

TOSVERT VF-AS3

RS485 Communication Function Instruction Manual

Safety precautions

ICommunication
function overview**1**Transmission
specifications**2**RS485 communication
wiring diagram**3**Selecting
communication protocol**4**TOSHIBA
inverter protocol**5**MODBUS-RTU
protocol**6**Inverter-to-inverter
communication ([F806]
or [F826])**7**Communication-
related parameters**8**Control through
communication**9**

Parameter data

10<Appendix 1> Data
code table**A1**<Appendix 2>
Response time**A2**<Appendix 3> Inverter
type (FB05)**A3**<Appendix 4>
Troubleshooting**A4**

TOSHIBA INDUSTRIAL PRODUCTS AND SYSTEMS CORPORATION

Attention

1. Make sure that this instruction manual is received by those who actually uses the RS485 communication function.
2. Read this manual thoroughly before using the RS485 communication function. After reading this manual, keep it in a safe place for future maintenance and inspection.
3. The information in this manual is subject to change without prior notice.



I

Safety precautions

The items described in the instruction manual and on the inverter itself are very important so that you can use safely the inverter, prevent injury to yourself and other people around you as well as to prevent damage to property in the area.

Thoroughly familiarize yourself with the safety precautions in the inverter instruction manual (E6582062) and then continue to read the manual. Make sure that you observe all warnings given.



Description of display



Display	Meaning
 Warning	Indicates that "improper use may result in death or serious injury."
 Caution	Indicates that "improper use may result in injury or only property damage."*1*2

*1 Injury means injury, burn, electric shock, etc. that do not require hospitalization or long-term hospital visits for treatment.

*2 Property damage means extended damage related to damage to the properties and materials.

Meaning of symbols

Display	Meaning
 Mark	Indicates prohibition (matters prohibited). The concrete contents are indicated inside or near the symbol with a picture or text.
 Mark	Indicates instructions (matters to be observed without fail). The concrete contents are indicated inside or near the symbol with a picture or text.
 Mark	Indicates a warning or caution. The concrete contents are indicated inside or near the symbol with a picture or text.

 Caution		Reference page
 Prohibited	<ul style="list-style-type: none"> • Do not connect Ethernet to the RS485 communication connector. This can result in malfunction. • Do not connect or disconnect the communication cable when power is ON. This can result in malfunction. 	-> Refer to [Chapter 3]
 Mandatory action	<ul style="list-style-type: none"> • The number of times of writing a parameter to EEPROM must be 100,000 or less. EEPROM has a life that expires with writing of approx. 100000 times. Command parameters (some exceptions -> Refer to Command parameters in [10.Parameter data]) have only RAM but no EEPROM, so there is no limit to the number of writing times. When TOSHIBA inverter protocol is used and if there is no need to store data, you can write only to RAM (using a P command). • Set the parameter of communication time-out. The devices cannot be stopped when a communication error occurs. 	-> Refer to [5. 2 Transmission command] -> Refer to [Chapter 5] -> Refer to [Chapter 6]

Contents

1	Communication function overview	1-1
2	Transmission specifications	2-1
3	RS485 communication wiring diagram	3-1
4	Selecting communication protocol	4-1
	4. 1 Reception frame completion process	4-1
5	TOSHIBA inverter protocol	5-1
	5. 1 TOSHIBA inverter protocol transmission format	5-2
	5. 1. 1 ASCII mode transmission format	5-2
	5. 1. 2 Binary mode transmission format	5-5
	5. 1. 3 Block communication transmission format	5-8
	5. 2 Transmission command	5-13
	5. 3 Transmission error	5-16
	5. 4 Broadcast communication function	5-17
	5. 5 Usage examples	5-19
6	MODBUS-RTU protocol	6-1
	6. 1 MODBUS-RTU transmission format	6-2
	6. 1. 1 One word reading command (03H)	6-3
	6. 1. 2 Block reading command: Indirect reading (03H)	6-4
	6. 1. 3 Block reading command: Direct reading (03H)	6-7
	6. 1. 4 Word writing command (06H/10H)	6-9
	6. 1. 5 Block writing command: Indirect writing (10H)	6-11
	6. 1. 6 Block writing and reading command: Indirect writing and reading (17H)	6-13
	6. 1. 7 Model information reading command (2BH)	6-16
	6. 2 CRC calculation	6-18
	6. 3 Error code	6-19
7	Inverter-to-inverter communication ([F806] or [F826])	7-1
	7. 1 Speed proportional control ([F810] to [F814])	7-5
	7. 2 Transmission format of inverter-to-inverter communication (reference)	7-8
8	Communication-related parameters	8-1
	8. 1 Baud rate ([F800] or [F820]), Parity bit ([F801] or [F821])	8-5
	8. 2 Inverter number ([F802])	8-5
	8. 3 Communication time-out detection function ([F803], [F804], [F808], or [F823], [F824], [F828])	8-6
	8. 4 Transmission wait time ([F805] or [F825])	8-7
	8. 5 Free memorandum ([F880])	8-8
	8. 6 Parameter writing ([F897])	8-8
	8. 7 Communication option reset ([F899])	8-8
9	Control through communication	9-1
	9. 1 Command through communication	9-1
	9. 2 Monitor through communication	9-9
	9. 3 Using the panel (LED, keys) through communication	9-21
	9. 3. 1 LED settings through communication	9-21

10	Parameter data	10-1
A1	<Appendix 1> Data code table	A1-1
A2	<Appendix 2> Response time	A2-1
A3	<Appendix 3> Inverter type (FB05)	A3-1
A4	<Appendix 4> Troubleshooting	A4-1

1

Communication function overview

I

1

2

3

4

5

6

7

8

9

10

A1

A2

A3

A4

This instruction manual describes an RS485 communication interface embedded in TOSVERT VF-AS3.

Caution



Prohibited

- Do not connect Ethernet to the RS485 communication connector. This can result in malfunction.

- A: Standard function RS485 communication connector 1 using a 2-wire RS485 communication port
(The operation panel is mounted by default.)
- B: Standard function RS485 communication connector 2 using a 2-wire/4-wire RS485 communication port
(A 2-wire port can be used with the default setting.)

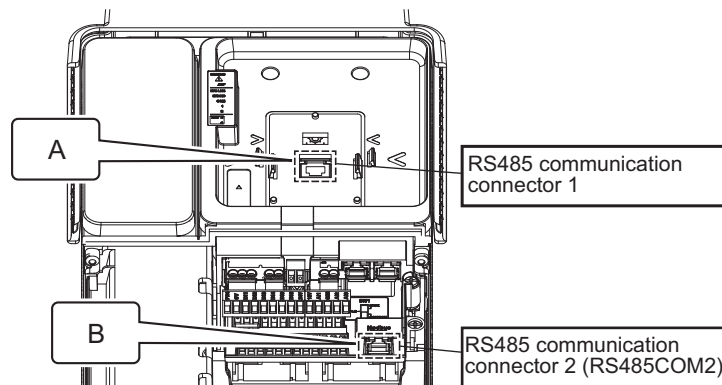

In VF-AS3, you can use the computer link function to carry out data communication between the controller (hereinafter referred to as computer) and the inverter by connecting the optional USB communication conversion unit (USB001Z).

Available communication protocols are TOSHIBA inverter protocol and MODBUS-RTU protocol. You can set which protocol to use in [F807: RS485 (1) protocol] or [F827: RS485 (2) protocol].-> Refer to [4. Selecting communication protocol]

<Computer link function>

Regardless of using TOSHIBA inverter protocol or MODBUS-RTU protocol, you can pass on the following information to the computer by creating a program according to the procedures described later.

- (1) Monitoring inverter status (such as the output frequency, current, and voltage)
- (2) Sending Run/Stop and other control commands to the inverter
- (3) Reading and writing inverter parameter settings

1

Supported communication codes are JIS (ASCII) code and Binary (HEX) code. It is assumed that JIS (ASCII) code is used to communicate with a computer, such as a PC, and Binary (HEX) code is used to communicate with a microcomputer, such as a control instrument. Data is accessed with a communication number.

* A bit is the minimum unit of information used in computers and expressed by 0 or 1. A group of 16 bits is called a word. In VF-AS3 communication function, this word unit is basically used to describe the amount of data. A word can handle data of 0 to FFFFH in hexadecimal format (0 to 65535 in decimal format).

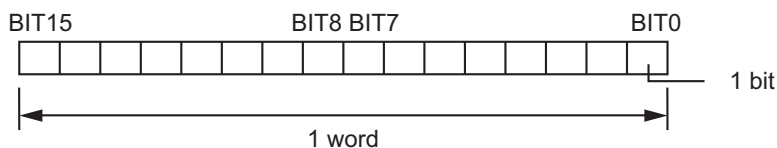

2

Transmission specifications

Bold font indicates the default setting.

Item	Specifications
Transmission scheme	Half duplex
Synchronization scheme	Start-stop synchronization
Communication baud rate	9600/ 19200 /38400 (Parameter setting) ^{*1}
Communication protocol	TOSHIBA inverter protocol /MODBUS-RTU (Parameter setting) ^{*1}
Character transmission	<ASCII mode> JIS X0201 8-bit (ASCII) <Binary mode, MODBUS-RTU> Binary codes fixed to 8 bits
Stop bit length	Received by inverter: 1bit/Sent by inverter: 2 bits ^{*3}
Error detecting scheme	Parity: ^{*2} Even /Odd/Non parity (selectable using a parameter) ^{*1} , Checksum (TOSHIBA inverter protocol), CRC (MODBUS-RTU)
Character transmission format	11-bit characters ^{*3} (Stop bit =1, with parity)
Order of bit transmission format	LSB first
Frame length	Variable

*1 After changing the baud rate setting or communication parity setting, turn off or reset the inverter to reflect the setting.

*2 All messages transmitted in ASCII mode have a vertical parity bit (even) defined in JIS-X-5001 added by using Roman 8-bit codes compliant with JIS-X-0201 (ANSI). In the parameter setting, you can change it to an odd parity (reflected after reset).

*3 Character transmission is as follows.

When received by inverter: 11 bits (1 start + 8 bits + parity + 1 stop)

START BIT									PARITY BIT	STOP BIT
	BIT0	BIT1	BIT2	BIT3	BIT4	BIT5	BIT6	BIT7		

The inverter receives with 1 stop bit.
(The computer can send with 1, 1.5, or 2 stop bit.)

When sent by inverter: 12 bits (1 start + 8 bits + parity + 2 stop)

START BIT									PARITY BIT	STOP BIT	STOP BIT
	BIT0	BIT1	BIT2	BIT3	BIT4	BIT5	BIT6	BIT7			

The inverter sends with 2 stop bit.
(The computer can receive with 1, 1.5, or 2 stop bit.)

3

RS485 communication wiring diagram

Caution



Prohibited

- Do not connect Ethernet to the RS485 communication connector. Incorrect wiring can result in malfunction.

■ RS485 communication connector 1

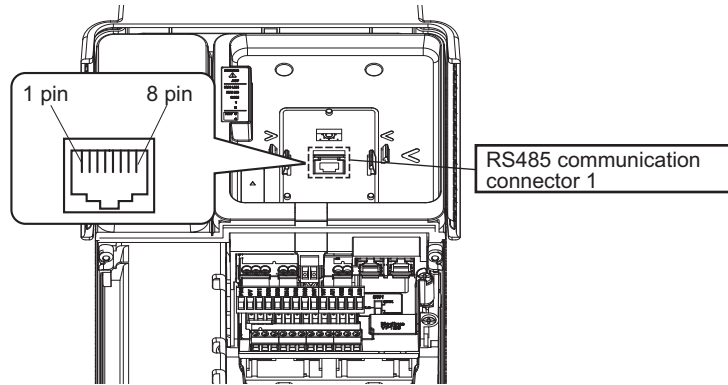

Signal name	Pin arrangement	Description
RXA+/TXA+	4	Non-inverting transmitted and received data
RXB-/TXB-	5	Inverting transmitted and received data
SG	8 (3)	Signal ground
-	1, 2, 6	- (connection prohibited)
-	7	Power (connection prohibited)

■ Wiring example

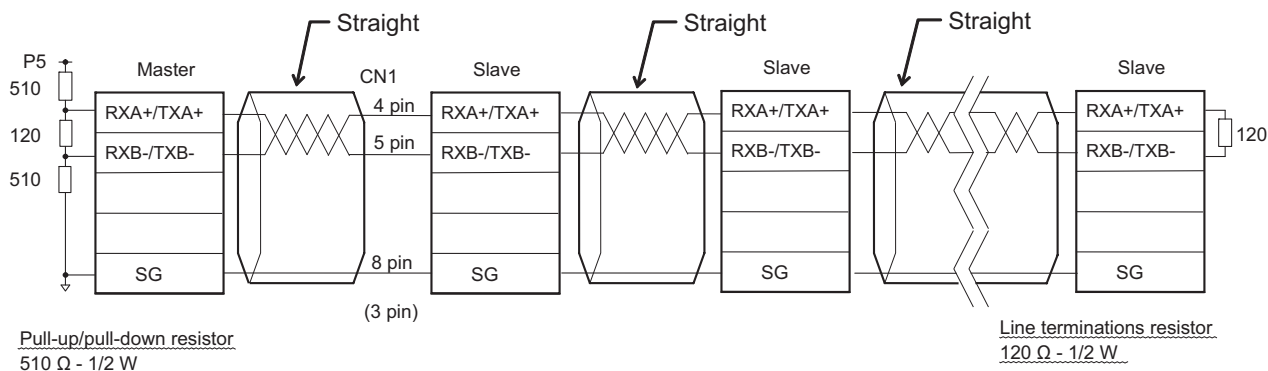

3

* Do not connect the 7 pin (power).



Important

- Be sure to use the pull-up/pull-down resistor and line terminations resistors.

■ RS485 communication connector 2

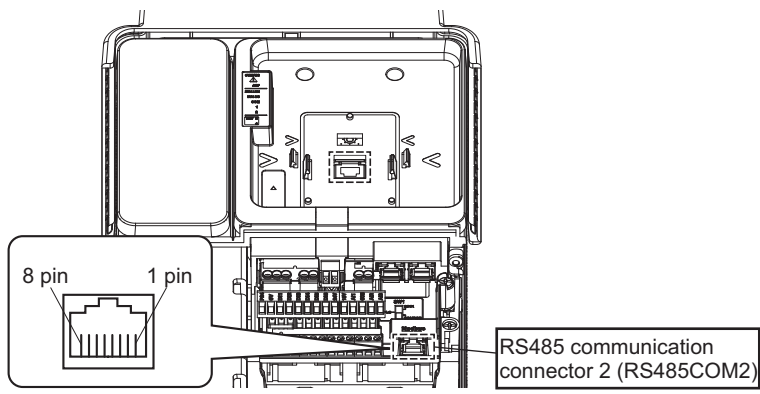

3

Signal name		Pin arrangement	Description
2-wire [F829] = "0"	4-wire [F829] = "1"		
RXA+/TXA+	RXA	4	Non-inverting transmitted and received data
			Non-inverting received data
RXB-/TXB-	RXB	5	Inverting transmitted and received data
			Inverting received data
-	TXA	3	Non-inverting transmitted data
-	TXB	6	Inverting transmitted data
SG		8	Signal ground
-		1, 2	Open (connection prohibited)
-		7	Power (connection prohibited)

Signal wires seen from the inverter.

■ Wiring example for 2-wire

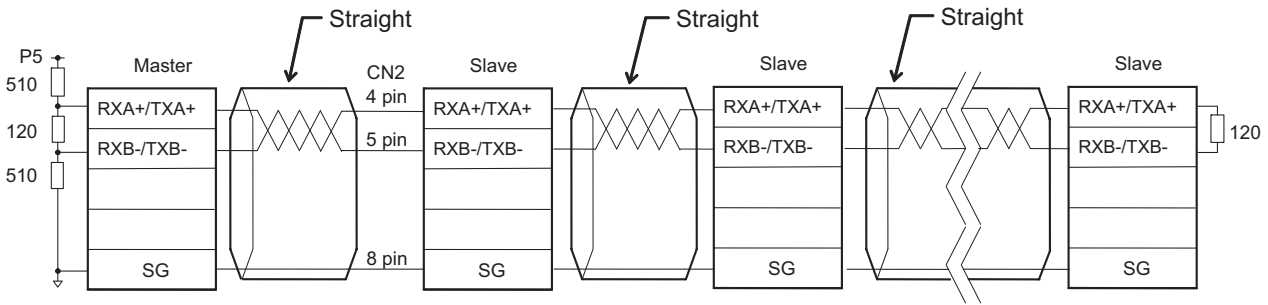

Pull-up/pull-down resistor
120, 510 Ω - 1/2 W

Line terminations resistor
120 Ω - 1/2 W

3

Cautions for wiring

- To use RS485 in 2-wire, set [F829: RS485 (2) wiring type] to "0: 2-wire."
- Do not connect the 7 pin (power).

■ Wiring example for 4-wire

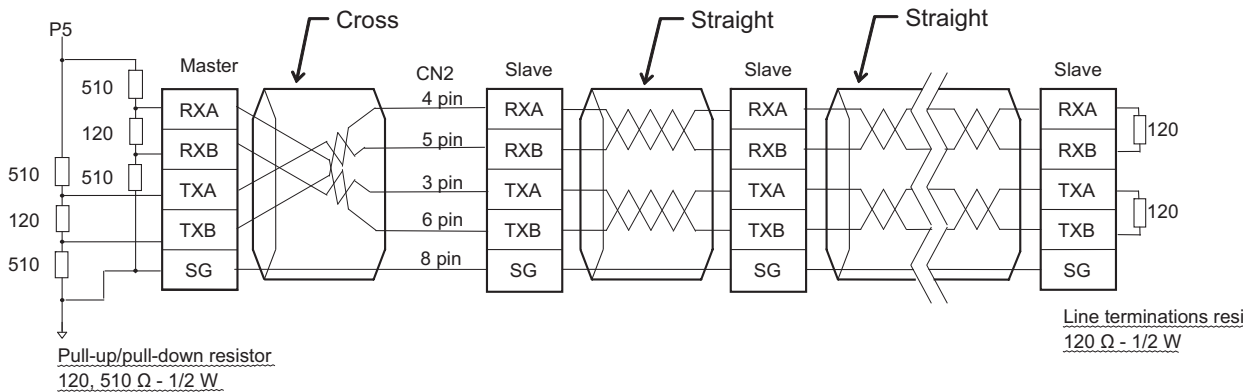

Pull-up/pull-down resistor
120, 510 Ω - 1/2 W

Line terminations resi
120 Ω - 1/2 W

Cautions for wiring

- To use RS485 in 4-wire, set [F829: RS485 (2) wiring type] to "1: 4-wire."
- Do not connect the 1 and 2 pins (open) and 7 pin (power).
- Do not bundle the communication cables and the main circuit wiring but keep a distance of 20 cm or more.
- In the twisted pair cables, twist RXA and RXB, and TXA and TXB.
- Connect line terminations resistors at both terminals of whole serial bus.
- When using in inverter-to-inverter communication, the leader side receipt (4.5 pin)/follower side (3.6 pin) line does not need to be connected.



Important

- Be sure to use the pull-up/pull-down resistor and line terminations resistors.

- Recommended parts

Recommended cable : Balanced twisted pair cable with the minimum conductor size of AWG24 (0.22 mm²) and a characteristic impedance of 100 to 120Ω

Recommended connector : RJ45 modular plug

4

Selecting communication protocol

Supported communication protocols are TOSHIBA inverter protocol and part of MODBUS-RTU protocol.

Select the protocol in [F807: RS485 (1) protocol] or [F827: RS485 (2) protocol].

Title	Communication No.	Parameter name	Adjustment range	Default setting
F807	0807	RS485 (1) protocol	0: TOSHIBA 1: MODBUS	0
F827	0827	RS485 (2) protocol		0

- The parameter change is reflected after reset, such as power-off.

4. 1 Reception frame completion process

To transmit/receive frame data, the frame synchronization scheme, where the start and end of a frame are recognized, is defined with dataless time (blank time of 3.5 bytes).

After starting receiving, if data communication is not carried out in the current communication baud rate for a time of 3.5 bytes or more (9600 bps: Approx. 4 ms or more, 19200: Approx. 2 ms or more, 38400 bps: Approx. 1 ms or more), the reception is judged to be complete, and the frame information is analyzed. For this reason, the frame transmission interval must be 3.5 bytes or more.

When continuously controlling multiple inverters on the same line individually, all inverters on the same line receive not only transmission frames from the computer to the inverter but also reply frames from the inverter to the computer. In this case, transmission from the computer to the next inverter requires a blank time of 3.5 bytes or more after receiving a reply frame. Otherwise, a reply frame + a transmission frame are analyzed as one frame, resulting in abnormal communication.

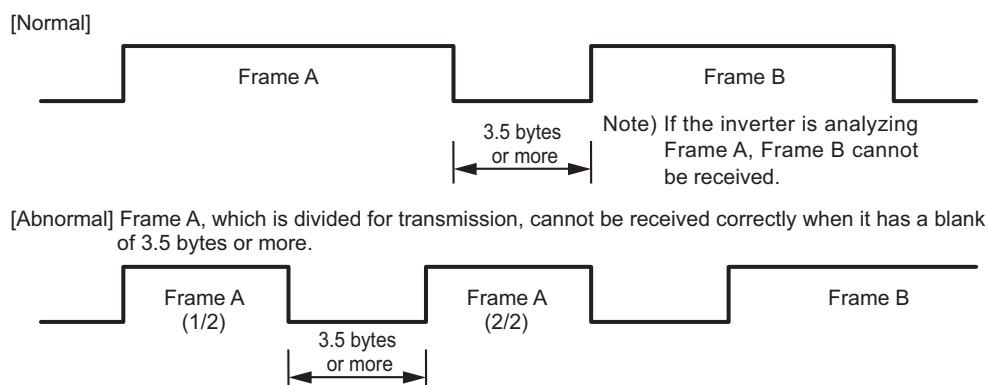

5

TOSHIBA inverter protocol

I

1

2

3

4

5

6

7

8

9

10

A1

A2

A3

A4

Set [F807: RS485 (1) protocol] or [F827: RS485 (2) protocol] to "0: TOSHIBA." In the default setting, both [F807] and [F827] are set to "0: TOSHIBA."-> Refer to [4. Selecting communication protocol]

Caution



Mandatory
action

- Set the parameter of communication time-out
The devices cannot be stopped when a communication error occurs.

■ Data exchange with the inverter

The inverter is always waiting for receiving data and responds to requests from the computer. The header code automatically determines ASCII mode or Binary mode.

	Header code	"CR" (Carriage return)
ASCII mode	"("	Required
Binary mode	"2FH(/)"	Not required

- 1 If the transmission format or inverter number is mismatched, the inverter causes a transmission error and does not respond.
- 2 When the inverter number is added, communication is available only in broadcast communication or if the inverter number is matched. If the inverter number is mismatched, the inverter does not respond.
- 3 If [F803: RS485 (1) time-out time] or [F823: RS485 (2) time-out time] is set, a communication time-out occurs when normal communication does not start within the set time. Set the inverter operation when a communication timeout occurs in [F804: RS485 (1) time-out operation] or [F824: RS485 (2) time-out operation] and the detection condition in [F808: RS485 (1) time-out detection] or [F828: RS485 (2) time-out detection].-> Refer to [8. 3]
- 4 The inverter processes a received command and then returns data to the computer. Details of the response time -> Refer to [A2. <Appendix 2> Response time]



Important

- Communication is not possible for approx. two seconds after the power of the inverter body is turned on until the initial setting is completed. If the control power goes off due to momentary power failure, communication becomes temporarily unavailable.

5. 1 TOSHIBA inverter protocol transmission format

5. 1. 1 ASCII mode transmission format

Specify data with a communication number, and describe the data format in hexadecimal and character transmission with JIS-X-0201 (ASCII (ANSI)).

■ Computer -> inverter

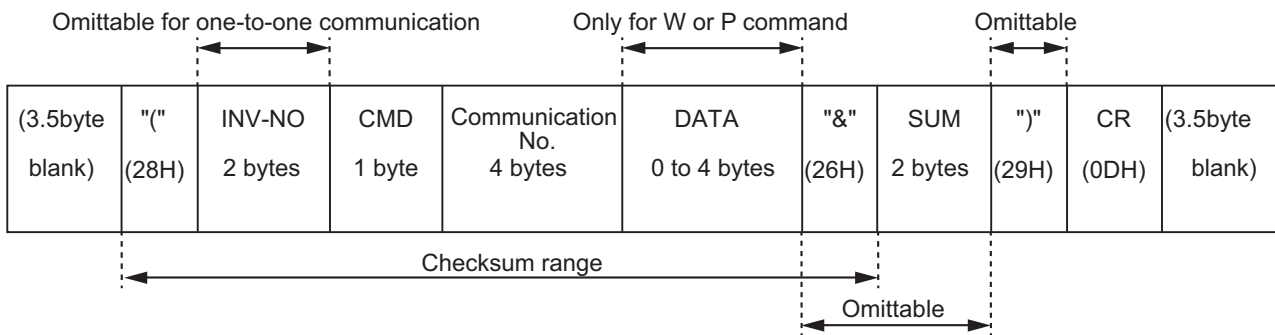

1. "(" (1 byte) : ASCII mode header code
2. INV-NO (2 bytes) : Inverter number (omittable for one-to-one communication)...
 00 (30H, 30H) to 99 (39H, 39H), * (2AH)
 A command is executed only when it matches the inverter number in the parameter setting.
 (When "*" is specified in broadcast communication, if the number without "*" is matched, it is judged to be matched. If both of two digits are "*", all connected inverters are judged to be matched.)
 If the inverter number is mismatched or has one-digit, it is invalid, and data is not returned.
3. CMD (1 byte) : Command (-> Refer to "Command and data details" shown below)
4. Communication number (4 bytes): Communication number -> Refer to [10. Parameter data]
5. DATA (0 to 4 bytes) : Write data (only available for W and P commands)
6. "&" (1 byte) : Checksum discrimination code (omittable) If the code is omitted, omit the checksum as well.
7. SUM (2 bytes) : Checksum (omittable)
 Add an ASCII coded number of the last two digits (4 bits/digit) of a total sum (sum of ASCII codes) ranging from the header code to the checksum discrimination code.
 Example: (R0000&??)CR
 $28H + 52H + 30H + 30H + 30H + 30H + 26H = 160H$
 The checksum is the last two digits (??) = 60
 If the checksum is omitted, omit the checksum discrimination code as well.
8. ")" (1 byte) : End code (omittable)
9. CR (1 byte) : Carriage return code

Command and data details

CMD (1 byte)	Write data (0 to 4 bytes), hexadecimal
R (52H) : RAM data read command	No data
W (57H) : RAM/EEPROM data write command	Write data (0000H to FFFFH)
P (50H) : RAM data write command	Write data (0000H to FFFFH)

■ Inverter -> computer

For non-responding inverters in broadcast communication, or if the inverter number is mismatched or has one-digit, data is not returned to prevent data conflicts during response.

●Response in normal process (ASCII mode)

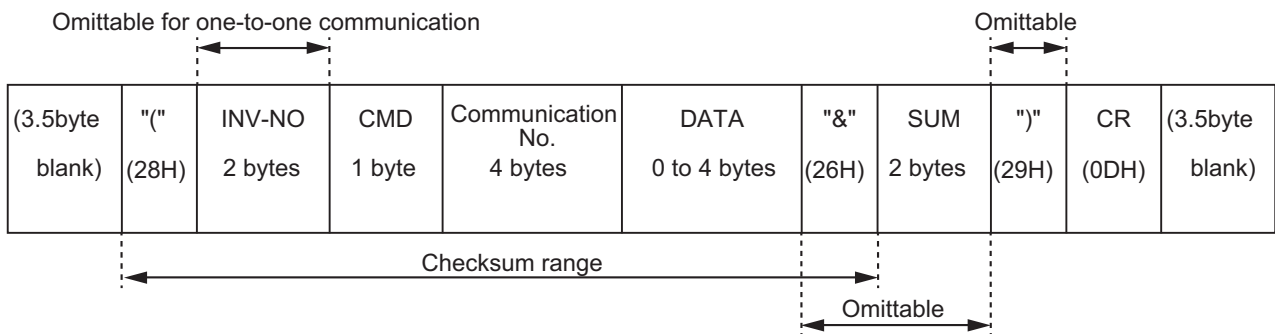

1. "(" (1 byte) : ASCII mode header code
2. INV-NO (2 bytes) : Inverter number (omitted when it is omitted for reception)...
 00 (30H, 30H) to 99 (39H, 39H)
 If it matches the inverter number in the parameter setting, or for the responding inverter (matches the minimum value of a valid number) in broadcast communication, the inverter returns data.
 In broadcast communication, a value other than the minimum value of a valid number is not returned.
 Example: (*2R0000)CR -> (02R00000000)CR
 Only the inverter number = 02 responds. 12 or 22 does not respond.
3. CMD (1 byte) : Command....Used to check inverter trip as well.
 At normal operation.....Returns a received command (R, W, or P).
 At trip.....Returns a received command in lowercase (r, w, or p). (A received command is returned with 20H added.)
4. Communication number (4 bytes) : Communication number....Returns a received communication number.
5. DATA (4 bytes) : Data...A command R returns read data, and a command W or P returns received data. Even when received data has less than four digits, data is returned after converted to four digits.
 Example: (W123412)CR -> (W12340012)CR
6. "&" (1 byte) : Checksum discrimination code (omitted when it is omitted for reception)

- 7. SUM (2 bytes) : Checksum... Omitted when the checksum discrimination code is omitted for reception.
Add an ASCII coded number of the last two digits (4 bits/digit) of a total sum (sum of ASCII codes) ranging from the header code to the checksum discrimination code of response data.
- 8. ")" (1 byte) : End code (omitted when it is omitted for reception)
- 9. CR (1 byte) : Carriage return code

•Response in abnormal process (ASCII mode)

When a communication error occurs, a communication error command (N or n) and an error type number are set, and data is returned to the computer.

However, for other than the responding inverter in broadcast communication, or if the inverter number is mismatched or has one-digit, data is not returned to prevent data conflicts during response.

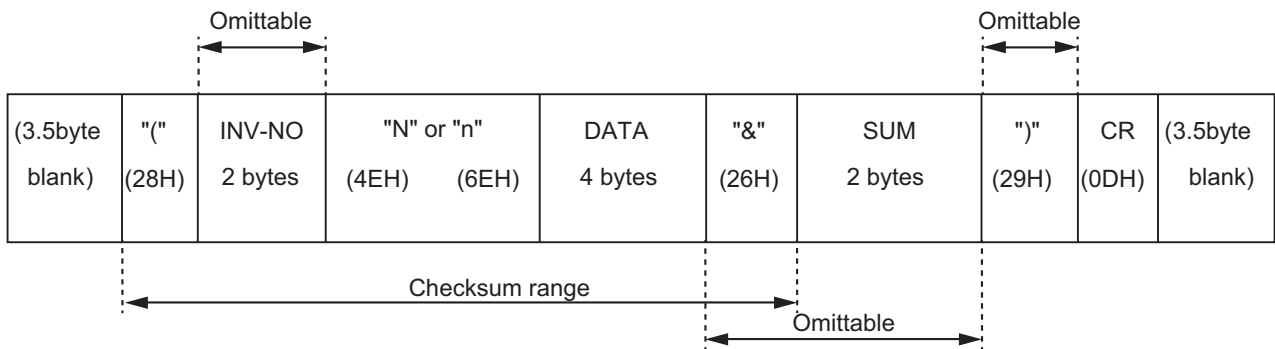

- 1. "(" (1byte) : ASCII mode header code
- "N" or "n" (1 byte) : Communication error command.... Used to check inverter trip as well.
"N" is for normal operation, and "n" is for inverter trip.
- INV-NO (2 bytes) : Inverter number (omitted when it is omitted for reception)...
00 (30H, 30H) to 99 (39H, 39H)
If it matches the inverter number in the parameter setting, or for the responding inverter (matches the minimum value of a valid number) in broadcast communication, the inverter returns data.
- DATA (4 bytes) : Error code (0000 to 0004)
0000... Non-executable (communication is all normal but cannot execute:
Writing to a change lockout during run parameter (maximum frequency, etc.), during an EEPROM error)
0001... Data error (the set data value is out of range, or the number of data digits is large)
0002... Communication number error (the target communication number is not found)
0003... Command error (the target command is not found)
0004... Checksum error (the checksum is mismatched)
-)" (1 byte) : End code (omitted when it is omitted for reception)

Examples

- (N0000&5C)CR... Non-executable (the maximum frequency data is changed during operation, etc.)
- (N0001&5D)CR... Data error (the set data value is out of the adjustment range)
- (N0002&5E)CR... Communication number error (the target communication number is not found)
- (N0003&5F)CR... Command error (the command is other than R, W, and P)
(Example: L, S, G, a, b, m, r, w, t,...)
- (N0004&60)CR... Checksum error (the checksum data is mismatched)
- No response..... Format error, illegal inverter number

5. 1. 2 Binary mode transmission format

Specify data with a communication number, and describe the data format in hexadecimal and character transmission data with Binary code (HEX code).

■ Computer -> inverter (Binary mode)

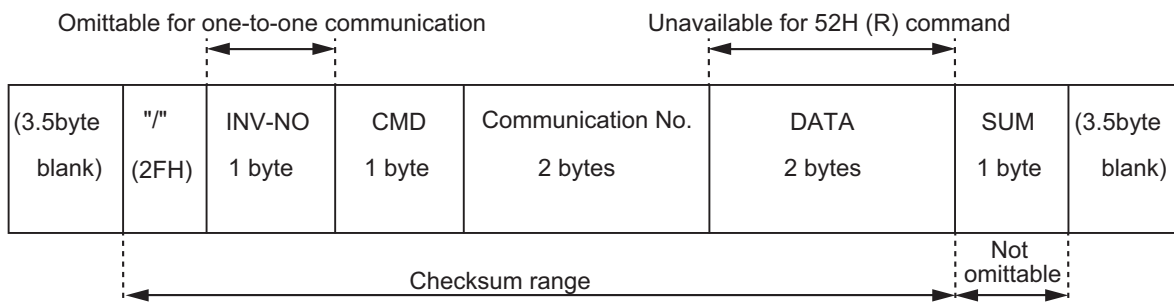

1. 2FH ("/') (1 byte) : Binary mode header code
2. INV-NO (1 byte) : Inverter number (omittable for one-to-one communication)...00H to 3FH, FFH
For other than FFH (broadcast communication), a command is executed only when it matches the inverter number in the panel setting.
If the inverter number is mismatched, it is invalid, and data is not returned.
3. CMD (1 byte) : Command (refer to the details shown below)
For "52H (R)," data following CMD is fixed to 3 bytes.
(2 bytes for communication number and 1 byte for checksum)
For "57H (W)," "50H (P)," or "47H (G)," data following CMD is fixed to 5 bytes.
(2 bytes for communication number, 2 bytes for data, and 1 byte for checksum)
For other than the above commands, it is invalid, and an error is not returned.
4. Communication number (2 bytes): Communication number -> Refer to [10. Parameter data]
5. DATA (2 bytes) : Data...0000H to FFFFH
For a "57H (W)" or "50H (P)" command, it is write data (with range check)
For "47H (G)," dummy data (example: 0000) is required,
for "52H (R)," DATA is unavailable (add inhibited)

- 6. SUM (1 byte) : Checksum (not omittable) 00H to FFH
 Number of the last two digits (1 byte) of a total sum ranging from the header code to DATA (communication number for 52H (R) command) of transmission data
 Example: 2F 52 00 00 ??... 2FH + 52H + 00H + 00H = 81H
 The checksum is the last two digits (??) = 81

Command and data details

CMD (1 byte)	Write data (0 to 4 bytes), hexadecimal
52H (R) : RAM read command	No data
57H (W) : RAM/EEPROM write command	Write data (0000H to FFFFH)
50H (P) : RAM write command	Write data (0000H to FFFFH)
47H (G) : RAM read command (for 2-wire)	Dummy data (0000H to FFFFH)

■ Inverter -> computer (Binary mode)

For other than the responding inverter (with the inverter number 00H) in broadcast communication in Binary mode, or if the inverter number is mismatched, data is not returned to prevent data conflicts during response.

● Response in normal process (Binary mode)

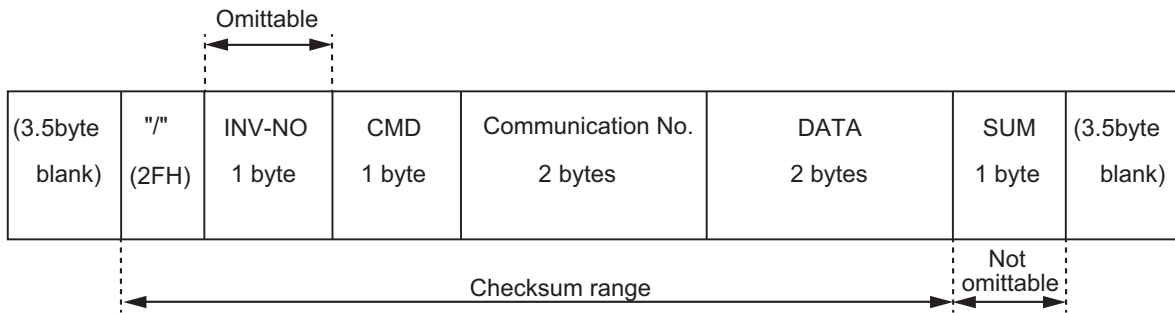

1. 2FH ("") (1 byte) : Binary mode header code
2. INV-NO (1 byte) : Inverter number (omitted when it is omitted for reception)...
 00H to 3FH
 Only if it matches the inverter number in the panel setting, or for the responding inverter number (00H) in broadcast communication, the inverter returns data.
3. CMD (1 byte) : Command....Used to check inverter trip as well.
 Normal operation..... Returns a received command (52H (R), 47H (G), 57H (W), or 50H (P)).
 At trip.. Returns a received command in lowercase (72H (r), 67H (g), 77H (w), or 70H (p)). (A received command is returned with 20H added.)
4. Communication number (2 bytes): Communication number....Returns a received number.
5. DATA (2 bytes) : Data... 0000H to FFFFH
 A command "52H (R)" or "47H (G)" returns read data, and a command "57H (W)" or "50H (P)" returns write data.
6. SUM (1 byte) : Checksum (not omittable) 00H to FFH
 Number of the last two digits (1 byte) of a total sum ranging from the header code to DATA of response data.

● **Response in abnormal process (Binary mode)**

When a communication error occurs, a communication error command (4EH (N) or 6EH (n)) and an error type number are set, and data is returned to the computer with the checksum added. However, for other than the responding inverter (with the inverter number 00H) in broadcast communication in Binary mode, or if the inverter number is mismatched, data is not returned to prevent data conflicts during response.

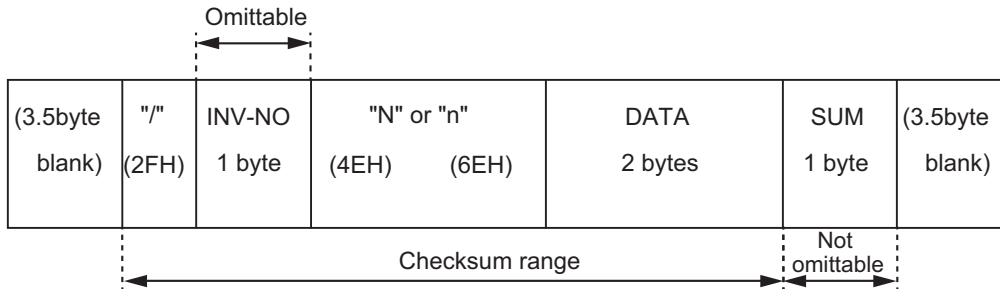

"N" or "n" (1 byte) : Communication error command...Used to check inverter trip as well.
 "4EH (N)" is for normal operation, and
 "6EH (n)" is for inverter trip.

DATA (2 bytes) : Error code (0000 to 0004)
 0000... Non-executable (communication is all normal but cannot execute:
 Writing to a change lockout during run parameter (maximum frequency, etc.), during an EEPROM error)
 0001... Data error (the set data value is out of range, or the number of data digits is large)
 0002... Communication number error (the target communication number is not found)
 0004... Checksum error (the checksum is mismatched)
 No response... Command error, format error (parity, overrun, or framing error), mismatched inverter number, or other than the responding inverter (with the inverter number 00H) in broadcast communication in Binary mode

Examples

- 2FH, 4EH, 00H, 00H, 7DH...
 Non-executable (the maximum frequency data is changed during operation, etc.)
- 2FH, 4EH, 00H, 01H, 7EH...
 Data error (data out of the adjustment range is set)
- 2FH, 4EH, 00H, 02H, 7FH...
 Communication number error (the target communication number is not found)
- 2FH, 4EH, 00H, 04H, 81H...
 Checksum error (the checksum data is mismatched)

5. 1. 3 Block communication transmission format

*** What is block communication?**

By presetting the type of data to communicate in the block communication parameters ([F870], [F871], [F875] to [F879]), multiple set data can be written and read with single communication. Block communication can reduce communication time.

Describe the data format in hexadecimal and character transmission with Binary (HEX) code.

"Computer -> inverter" is only for write, and its responding "inverter -> computer" is only for read.

■ Computer -> inverter (Block communication)

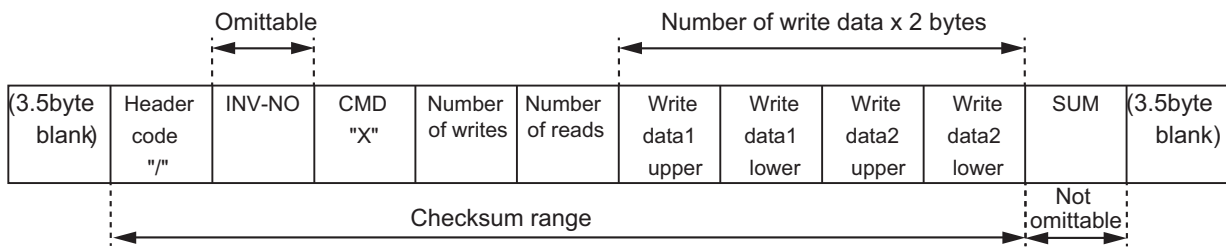

1. 2FH ("2FH") (1 byte) : Binary mode header code
2. INV-NO (1 byte) : Inverter number (omittable for one-to-one communication)....00H to 3FH, FFH
 For other than FFH (broadcast), it is executed only when it matches the inverter number in the panel setting.
 If the inverter number is mismatched, communication data is invalid, and data is not returned.
3. CMD (1 byte) : 'X' (Block communication command (command))
4. Number of writes (1 byte) : Specify the number of data to write (00H to 02H).
 If it is out of range, it is judged a format error, and data is not returned.
5. Number of reads (1 byte) : Specify the number of data to read (00H to 05H).
 If it is out of range, the inverter returns the number of reads = 0 when responding.
6. Write data 1 (2 bytes) : It is required when the number of writes is one or more.
 Write data to the parameter set in [F870: Block write data 1]
 Even when [F870] is "0: Disabled", if the number of writes is one or more, dummy data is required.
7. Write data 2 (2 bytes) : It is required when the number of writes is two.
 Write data to the parameter set in [F871: Block write data 2]
 Even when [F871] is "0: Disabled", if the number of writes is two, dummy data is required.
8. SUM (1 byte) : Checksum (not omittable) 00H to FFH
 Value of the last two digits (1 byte) of a total sum ranging from the header code to the write data 2 (not including the SUM value)

■ Block write 1 and 2

Set data that is written during block communication in [F870: Block write data 1] or [F871: Block write data 2]. The settings of these parameters are reflected after reset of power off, etc. After setting, reset the power once.

Number	Block write data	Data details reference
0	Disabled	-
1	FA00 (Communication command 1)	Refer to [9. 1 Command through communication]
2	FA20 (Communication command 2)	
3	FA01 (Frequency command)	
4	FA50 (TB output)	
5	FA51 (Analog output)	
6	FA13 (Speed command by communication)	

* If the parameter is set to "0: Disabled", writing is not performed even if write data is specified.

■ Block read 1 to 5

Set data that is read during block communication in [F875: Block read data 1] to [F879: Block read data 5]. The settings of these parameters are reflected after reset of power off, etc. After setting, reset the power once.

Number	Block read data	Data details reference
0	Disabled	-
1	FD01 (Status information)	Refer to [9. 2 Monitor through communication]
2	FD00 (Output frequency)	
3	FD03 (Output current)	
4	FD05 (Output voltage)	Refer to [10. Parameter data]
5	FC91 (Alarm information)	Refer to [9. 2 Monitor through communication]
6	FD22 (PID feedback value)	Refer to [10. Parameter data]
7	FD06 (Input terminal monitor)	Refer to [9. 2 Monitor through communication]
8	FD07 (Output terminal monitor)	
9	FE35 (Terminal RR monitor)	
10	FE36 (Terminal RX monitor)	
11	FE37 (Terminal II monitor)	
12	FD04 (Input voltage (DC detection))	
13	FD16 (Speed feedback frequency)	
14	FD18 (Torque)	

Number	Block read data	Data details reference
15	FE60 (My function output monitor 1)	-
16	FE61 (My function output monitor 2)	
17	FE62 (My function output monitor 3)	
18	FE63 (My function output monitor 4)	
19	0880 (Free memorandum)	Refer to [8. 5 Free memorandum ([F880])]
20	FD90 (Motor speed)	Refer to [9. 2 Monitor through communication]
21	FD29 (Input power)	Refer to [10. Parameter data]
22	FD30 (Output power)	
23	FC90 (Trip information)	Refer to [9. 2 Monitor through communication]

- * With "9: FE35 (Terminal RR monitor)", "10: FE36 (Terminal RX monitor)", and "11: FE37 (Terminal II monitor)", the data becomes retained data at the time of a trip. With others, the data becomes real-time data.
- * When the parameter is set to "0: Disabled," if read is specified, "0000" is returned as dummy data.

■ Inverter -> computer

For other than the responding inverter (with the inverter number 00H) in broadcast communication in Binary mode, or if the inverter number is mismatched, data is not returned to prevent data conflicts during response.

●Response in normal process

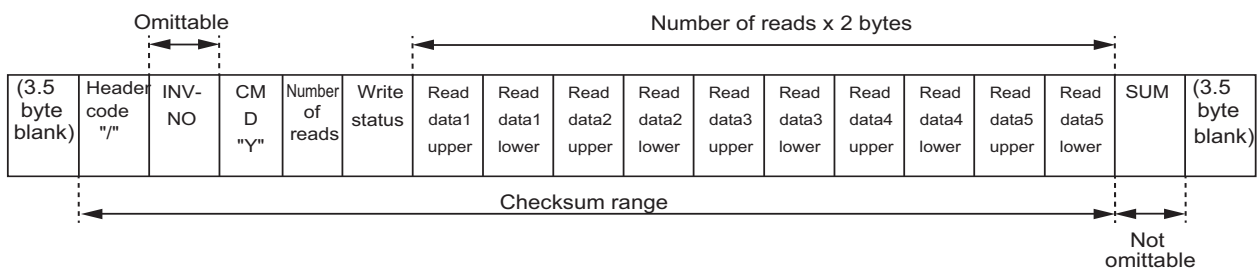

1. 2FH (") (1 byte) : Binary mode header code
2. INV-NO (1 byte) : Inverter number ...00H to 3FH
 Only if it matches the inverter number in the panel setting or the minimum value (00) of a valid number is matched in broadcast communication, the inverter returns data.
 In broadcast communication, inverters other than the one with the inverter number 00 do not respond.
 If the inverter number is mismatched, it is invalid, and data is not returned. (It is judged to be matched when it is omitted for reception.)
3. CMD (1 byte) : 'Y' (Block communication command (monitor))
 However, it is in lowercase ('y') at trip (including retry in process and during trip retention).

4. Number of reads (1 byte): Returns the number of reads (00H to 05H).

5. Write status (1 byte) : Returns 00H to 03H.

* If it fails to write to a specific parameter according to the number of writes, set the corresponding bit of the parameter to 1 (refer to the following).

bit position	7	6	5	4	3	2	1	0
Data type	-						[F871]	[F870]

6. Read data 1 to 5 (2 bytes): Returns according to the number of reads. When the parameter is set to 0, 0000H is returned as dummy data.

Data selected in Read data 1 = [F875], data selected in Read data 2 = [F876]

Data selected in Read data 3 = [F877], data selected in Read data 4 = [F878]

Data selected in Read data 5 = [F879]

7. SUM (1 byte) : Checksum (not omissible) 00H to FFH

Value of the last two digits (1 byte) of a total sum ranging from the header code to the read data of response data

Examples

When [F870] = "1: FA00 (Communication command 1)," [F871] = "3: FA01 (Frequency command)," [F875] = "1: FD01 (Status information)," [F876] = "2: FD00 (Output frequency)," [F877] = "3: FD03 (Output current)," [F878] = "4: FD05 (Output voltage)," and [F879] = "5: FC91 (Alarm information)" are set

Computer -> inverter: 2F 58 02 05 C4 00 17 70 D9

Inverter -> computer: 2F 59 05 03 00 00 00 00 00 00 00 00 00 00 90
(When the parameter is not set)

Inverter -> computer: 2F 59 05 00 40 00 00 00 00 00 00 00 00 00 CD
(When the parameter is set)

Inverter -> computer: 2F 59 05 00 64 00 17 70 1A 8A 24 FD 00 00 3D
(During 60 Hz run)

●Response in abnormal process

When a communication error occurs, a communication error command (4EH (N) or 6EH (n)) and an error type number are set, and data is returned to the computer with the checksum added.

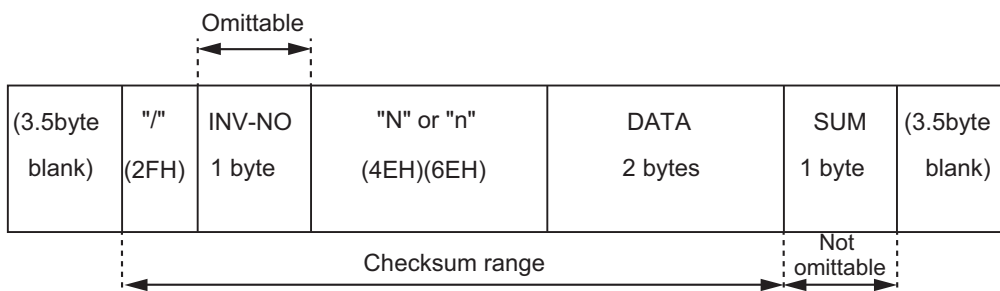

"N" or "n" (1 byte) : Communication error command... Used to check trip (including retry in process and during trip retention).
 "4EH (N)" is for normal operation, and "6EH (n)" is for inverter trip.

5

DATA (2 bytes) : Error code (0004)
 0004...Checksum error (the checksum is mismatched)
 No response... Command error, format error (parity, overrun, or framing error), mismatched inverter number, or other than the inverter number 00H in broadcast communication

Examples

Computer -> inverter: 2F 58 02 05 C4 00 17 70 D8

Inverter -> computer: 2F 4E 00 04 81...Checksum error

5.2 Transmission command

The types of commands for communication are as follows.

Command type	Function
W command	Writing to a specified communication number (RAM, EEPROM)
P command	Writing to a specified communication number (RAM)
R command	Reading a specified communication number
G command	Reading a specified communication number (dedicated for Binary mode, dummy data required)
S command	Inverter to inverter communication command (dedicated for Binary mode, no data response)
X command	Block communication command (computer -> inverter)
Y command	Block communication command (inverter -> computer)

■ **W (57H)** (RAM^{*1}/EEPROM^{*2} write)

A parameter specified with a communication number is changed to specified data. Data is written to RAM and EEPROM. However, even when a "W" command is used, if a parameter (communication number = FA00, etc.) is not supported by EEPROM, data is written only to RAM. Data cannot be written to read-only parameters (communication number = FD??, FE??, etc.).

While writing data, the data range for the parameter is checked by the inverter. If data is out of range, it is invalid, and an error is returned.

Example: Set the deceleration time (communication number: 0010) to 10 seconds

*CR: Carriage return

<ASCII mode>

Computer -> inverter Inverter -> computer
(W00100064) CR (W00100064) CR ... (10/0.1 = 100 = 0064H)

<Binary mode>

Computer -> inverter Inverter -> computer
2F 57 00 10 00 64 FA 2F 57 00 10 00 64 FA ... (10/0.1 = 100 = 0064H)

Caution



- The number of times of writing a parameter to EEPROM must be 100,000 or less. EEPROM has a life that expires with writing of approx. 100000 times. Command parameters (some exceptions -> Refer to Command parameter in [10.Parameter data]) have only RAM but no EEPROM, so there is no limit to the number of writing times. When TOSHIBA inverter protocol is used and if there is no need to store data, you can write only to RAM (using a P command).

Term description

- *1: RAM is actual data to control the inverter. When the inverter is turned off, data becomes invalid. When the inverter is turned on, parameter data in EEPROM is copied to RAM.
- *2: EEPROM stores parameters used to control the inverter. It retains data even after the inverter is turned off and copies data to RAM when the inverter is turned on or reset.

■ **P (50H)** (RAM*1 write)

Data in the parameter specified with a communication number is changed to any data. Data is written only to RAM. Data cannot be written to read-only parameters. While writing data, this checks whether or not it is within the parameter range. If data is out of range, it is invalid, and an error is returned.

Example: Perform emergency stop by communication (communication number: FA00)

<ASCII mode>

Computer -> inverter Inverter -> computer
 (PFA009000)CR (PFA009000)CR ... Command priority, emergency stop signal

<Binary mode>

Computer -> inverter Inverter -> computer
 2F 50 FA 00 90 00 09 2F 50 FA 00 90 00 09

■ **R (52H)** (Data read)

Data in the parameter specified with a communication number is read.

Example: Monitor the current (communication number: FE03)

<ASCII mode>

Computer -> inverter Inverter -> computer
 (RFE03) CR (RFE03077B) CR ... The current is 1915/100 = 19.15%

<Binary mode>

Computer -> inverter Inverter -> computer
 2F 52 FE 03 82 2F 52 FE 03 07 7B 04

■ **G (47H)** (Data read)

Data in the parameter specified with a communication number is read. This is two-wire RS485 communication used to control multiple units using Binary mode in old models. In the VF-AS3 series, it can be used even with an "R" command without any problems.

When a "G" command is used, dummy data (2 bytes) is required.

This command is available only in Binary mode.

Example: Monitor the current (communication number: FE03)

Computer -> inverter Inverter -> computer
 2F 47 FE 03 00 00 77 2F 47 FE 03 07 7B F9

* Data 00H in computer -> inverter is dummy data.

■ S (53H)/s (73H) Inverter to inverter communication command (RAM*1 write)

This is a command used to handle a frequency command value with % (1 = 0.01%) instead of Hz. This command is designed to perform synchronized/proportional operation but can also be used in normal computer link communication.

It is allowed to write to the frequency command (FA01). If a parameter other than this is specified, a communication number error occurs. Data is written only to RAM. When this command is used, the inverter does not return data.

This command is available only in Binary mode.

Details of the format -> Refer to [7. 2 Transmission format of inverter-to-inverter communication (reference)]

The unit of a frequency command value specified with an "S" command should be (%) instead of (Hz), and a frequency value is converted to Hz on the receiving device according to the point conversion parameter. The conversion formula is as follows.

Frequency command value (Hz) =

$$\frac{\text{Point 2 frequency [F814]} - \text{Point 1 frequency [F812]}}{\text{Point 2 [F813]} - \text{Point 1 [F811]}} \times (\text{Frequency command value (\%)} - \text{Point 1 [F811]}) + \text{Point 1 frequency [F812]}$$

While receiving an "s" command (lowercase), the slave judges that the master is tripping, and it operates according the setting in [F806: RS485 (1) inverter to inverter communication] or [F826: RS485 (2) inverter to inverter communication].-> Refer to [8. Communication-related parameters]

5

■ X (58H)/Y(59H) (Block communication command)

Data selected in [F870: Block write data 1] or [F871: Block write data 2] is written to RAM. When responding, data selected in [F875: Block read data 1] to [F879: Block read data 5] is read and returned.

-> Refer to [5. 1. 3 Block communication transmission format]

Example: Send a 60 Hz run command or monitor (monitor when already performing 60 Hz run) by communication

Parameter setting: [F870] = "1," [F871] = "3," [F875] = "1," [F876] = "2," [F877] = "3," [F878] = "4," and [F879] = "5"

<Binary mode>

Computer -> inverter

2F 58 02 05 C4 00 17 70 D9

Inverter -> computer

2F 59 05 00 64 00 17 70 1A 8A 24 FD 00 00 3D

5.3 Transmission error

■ Error code list

Error name	Description	Error code
Non-executable	Communication is normal but cannot be executed. (1) Writing to a change lockout during run parameter (maximum frequency, etc.)* ¹ (2) Writing to a parameter during initialization (3) When [F700: Parameter reading&writing access lockout] = "2: Writing locked (1+RS485)" or "4: Reading&Writing locked (3+RS485)" is set (4) Writing to [F738] when [F738: Password setting] is set	0000
Data error	The set data value is out of the adjustment range.	0001
Communication number error	The target communication number is not found. -> Example: For (R0)))CR, 0))) is judged a communication number.	0002
Command error	The target command is not found.	0003 (ASCII mode) No response (Binary mode)
Checksum error	The checksum is mismatched.	0004
Format error	The transmission format is mismatched. (1) The inverter number has one digit (ASCII mode) (2) The specified position does not receive the "CR" code (ASCII mode) (Example) The communication number has four or less digits. In the case of (R11)CR, 11)CR is judged a communication number without "CR," resulting in a format error. (3) A code other than the end code is set in the end code position ("")	No response
Reception error	A parity, overrun, or framing error occurs.* ²	No response

*1 For change lockout during run parameters, refer to information about "Write during running" in Table of parameters in the inverter instruction manual (E6582062).

*2 Parity error: The parity is mismatched.
Overrun error: New data was input while reading data.
Framing error: The stop bit position is not correct.

* An error defined as "No response" in the table is not returned to prevent data conflicts. If there is no response for a certain period of time, recognize that a communication error occurred and retry it later on the computer.

* If the inverter number is mismatched, it is not an error, but data is not processed and returned.

5.4 Broadcast communication function

Broadcast communication function is used to send a command (data write) to multiple inverters with single communication.

Only write (W, P) commands are available. Read (R, G) commands are unavailable. Like independent communication, the target inverters include ones with the integer number 0 to 99 (00H to 63H) in ASCII mode and with 0 to 63 (00H to 3FH) in Binary mode. For response from the inverter, responding inverters are limited to prevent transmit data conflicts.

- Broadcast communication "for all" (ASCII mode/Binary mode)

ASCII mode

By specifying "*" in the inverter number specification position in communication format, broadcast communication is enabled, and a command is sent to all connected available inverters (with the inverter number 0 to 99 (00 to 63H)).

Binary mode

By specifying "FF" in the inverter number specification position in communication format, broadcast communication is enabled, and a command is sent to all connected available inverters (with the inverter number 0 to 63 (00 to 3FH)).

<Responding inverter>

Only an inverter with the inverter number 00 returns data.

If you do not want data to be returned, do not set Inverter 00 in the network.

- Broadcast communication "by group" (only ASCII mode)

A broadcast communication command is sent to only an inverter with a number whose first decimal digit is the same as ? for *? and whose second decimal digit is the same as ? for ?? in the inverter number specification position in communication format.

(?: any number between 0 and 9)

<Responding inverter>

Only an inverter with the lowest inverter number in the group communication target range (an inverter that matches a number with "*" replaced by "0") returns data. If you do not want data to be returned, do not set an inverter that matches a number with * replaced by 0 in the network.

- Broadcast communication examples

Example: Set the communication frequency command value to 60 Hz.

(1) Upper host -> multiple inverters: Broadcast communication (ASCII mode)

Communication example of upper host -> inverter: (**PFA011770)_{CR}

Response example of inverter -> upper host: (00PFA011770)_{CR}

Only Inverter 00 responds, and a command is sent to all connected available inverters.

(2) Upper host -> specific inverter group: Group communication (ASCII mode)

Communication example of upper host -> inverter: (*9PFA011770)_{CR}

Response example of inverter -> upper host: (09PFA011770)_{CR}

Only Inverter 09 responds, and a command is sent to ten (09, 19, 29, 39, ...99) of all connected inverters.

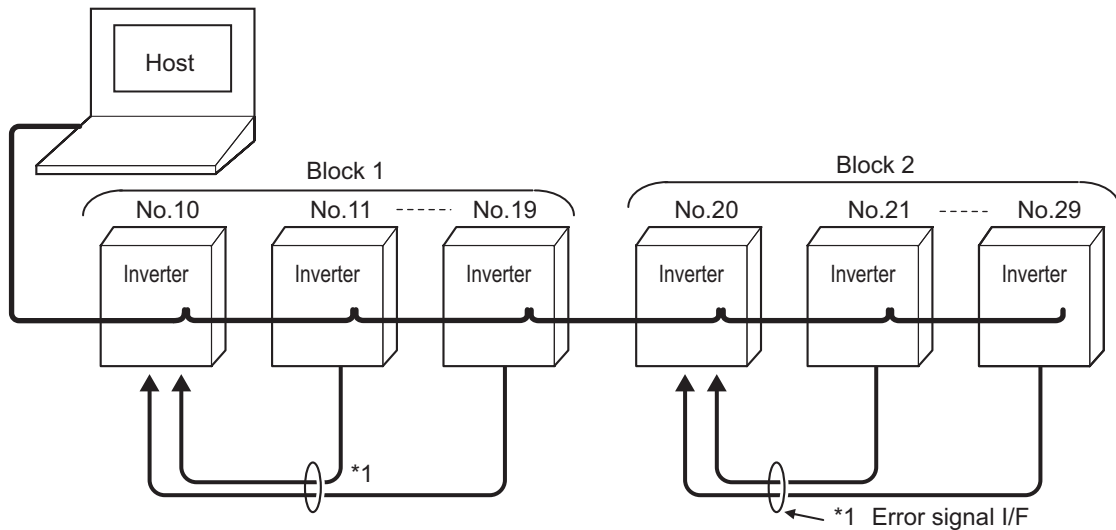

During broadcast communication, non-representative inverters do not respond to the computer. To report that an error occurs in any of blocks, use the following procedure:

- 1 In the setting for the communication time-out detection function ([F803], [F804], [F808], or [F823], [F824], [F828]), set the inverter to trip when a communication error occurs.
- 2 Assign the "failure signal" to the terminal [FL] (output terminal). [F132] = "10"
- 3 Assign "emergency stop" to the input terminal of the representative inverter of each group. Example) [F111: Terminal F function 1] = "20"
- 4 Connect the terminal [FL] of a non-representative inverter to the terminal [F] of the representative inverter.

When a non-representative inverter trips, inputting an emergency stop command to the representative inverter can send it to the computer (if a reply command from the representative inverter is in lowercase, it is detected that the inverter has an error).

To check the detailed error status, set an individual inverter number for the computer.

To send a command to all inverters in the above block, specify the inverter number "1*" for block 1 and "2*" for block 2. No.10 inverter responds for block 1, and No.20 inverter responds for block 2. For simultaneous broadcast communication, specify "***". In this case, an inverter with the inverter number "00" responds.

In the above example, if you want to report to the representative inverter without emergency stop, set the function of the input terminal of the representative inverter of each group to "0: No function." The computer can detect an error by individually checking the input terminal monitor (communication number = "FD06") of the representative inverter.



Important

- If an inverter with the same inverter number is connected in the network, data from inverters conflicts. Do not duplicate the inverter number in the same network.

5.5 Usage examples

The following examples show communication using communication commands. In these examples, the inverter number and ASCII mode checksum are omitted.

■ Communication example

Set the frequency command to 60 Hz using communication and perform forward run.

<ASCII mode>

<u>Computer -> inverter</u>	<u>Inverter -> computer</u>		
(PFA011770) CR	(PFA011770) CR	...	Set the frequency command to 60 Hz (60/0.01 Hz = 6000 = 1770H)
(PFA00C400) CR	(PFA00C400) CR	...	Enable the run command and the frequency command by communication and perform forward run.

<Binary mode>

<u>Computer -> inverter</u>	<u>Inverter -> computer</u>
2F 50 FA 01 17 70 01	2F 50 FA 01 17 70 01
2F 50 FA 00 C4 00 3D	2F 50 FA 00 C4 00 3D

Monitor the output frequency (during 60 Hz run)

<ASCII mode>

<u>Computer -> inverter</u>	<u>Inverter -> computer</u>		
(RFD00)CR	(RFD001770)CR	...	The output frequency is 60 Hz. (60/0.01 Hz = 6000 = 1770H)

<Binary mode>

<u>Computer -> inverter</u>	<u>Inverter -> computer</u>
2F 52 FD 00 7E	2F 52 FD 00 17 70 05

Monitor the inverter status

<ASCII mode>

<u>Computer -> inverter</u>	<u>Inverter -> computer</u>		
(RFD01)CR	(rFD010003)CR	...	Status details -> Refer to [9. 2 Monitor through communication] (During stop, during FL output, at trip (r command))

<Binary mode>

<u>Computer -> inverter</u>	<u>Inverter -> computer</u>
2F 52 FD 01 7F	2F 72 FD 01 00 03 A2

Monitor the trip code (currently during [Err5] trip) ...

Trip code details

-> Refer to Trip code monitor in [9. 2 Monitor through communication].

Refer to trip code monitor

(18H = 24d during [Err5] trip)

<ASCII mode>

Computer -> inverter

(RFC90)CR

Inverter -> computer

(rFC900018)CR

<Binary mode>

Computer -> inverter

2F 52 FC 90 0D

Inverter -> computer

2F 72 FC 90 00 18 45

6

MODBUS-RTU protocol

I

MODBUS-RTU protocol is supported only partially. All the data are binary codes.

Caution



Mandatory
action

- Set the parameter of communication time-out
The devices cannot be stopped when a communication error occurs.

1

2

3

4

5

6

7

8

9

10

A1

A2

A3

A4

■ Parameter setting

● Protocol selection ([F807] or [F827])

Set [F807: RS485 (1) protocol] or [F827: RS485 (2) protocol] to "1: MODBUS ." In the default setting, both [F807] and [F827] are set to "0: TOSHIBA." -> Refer to [4. Selecting communication protocol]

Note that inverter to inverter communication with [F806: RS485 (1) inverter to inverter communication] or [F826: RS485 (2) inverter to inverter communication] does not work.

● Inverter number ([F802])

The specified valid range of the inverter number of MODBUS-RTU is 0 to 247. However, set a communication number between 1 to 247 because 0 is for broadcast communication (no reply).

Set if necessary.

Baud rate: [F800: RS485 (1) baud rate] or [F820: RS485 (2) baud rate]

Parity: [F801: RS485 (1) parity] or [F821: RS485 (2) parity]

■ Data exchange with inverter

The inverter always waits for reception and responds upon request from the computer.

If the transmission format does not match, a transmission error occurs. The inverter does not respond in the case of a framing error, parity error, CRC error, and inverter number mismatch. If it does not respond after a certain period of time, consider that a communication error has occurred on the computer side. Try communication again.

- 1 Reception is completed when space of 3.5 bytes or more exists at the end of characters.
-> Refer to [4. 1 Reception frame completion process]
- 2 Communication is valid only when the inverter number matches or in the case of 0 (broadcast communication). When the inverter number does not match and in the case of 0 (broadcast communication), the inverter does not reply.
- 3 If the communication timer is set and no communication occurs within the set time after the initial communication, it is judged to be communication time-out, and the inverter is tripped.
-> Refer to [8. 3 Communication time-out detection function ([F803], [F804], [F808], or [F823], [F824], [F828])]

- 4 The inverter returns data to the computer after processing the receiving command.
Details of response time- > Refer to [A2. <Appendix 2> Response time]

 Important	<ul style="list-style-type: none"> Communication is not possible for approx. two seconds after the power of the inverter body is turned on until the initial setting is completed. If the control power supply is turned off due to a momentary power failure, communication is disabled temporarily.
--	--

6.1 MODBUS-RTU transmission format

Since MODBUS-RTU transmits and receives data without a head code for frame synchronization, the blank time to recognize the head of the frame is defined. The data that was received first after the blank time of 3.5 bytes at the current baud rate during reception waiting is judged to be the first byte of the frame.

[Normal format]

Blank time for 3.5 bytes	INV-NO	CMD	DATA	CRC16		Blank time for 3.5 bytes
	1byte	1byte	Variable length	low 1byte	high 1byte	

- (1) INV-NO (1 byte): Specify the inverter number. The specification range is 0 - 247 (00H - F7H). Command processing is executed only in the case of 0 (broadcast communication) and for the inverter that matches the inverter number setting. Though no reply is made in the case of 0 (broadcast communication) and when the inverter number does not match, do not use 248 - 255 (F8H - FFH) because they are used for manufacturer setting or option and a reply is made regardless of the inverter number.
- (2) CMD (1 byte) : Set the command. Details -> Refer to [6. 1. 1] to [6. 1. 7]

CMD		Function	Description	Reference
(Decimal)	(Hex)			
03	03H	One word reading	One parameter information reading	[6. 1. 1]
		Block reading	Synchronous reading of information set in [F875] to [F879] (Indirect: Up to five)	[6. 1. 2]
			Continuous reading from the specified address (Direct: Up to eight)	[6. 1. 3]
06	06H	One word writing	One parameter information setting	[6. 1. 4. (1)]
16	10H			[6. 1. 4. (2)]
16	10H	Block writing	Synchronous writing to information set in [F870] and [F871]	[6. 1. 5]

CMD		Function	Description	Reference
(Decimal)	(Hex)			
23	17H	Block writing and reading	Synchronous writing to information set in [F870] and [F871] and synchronous reading to information set in [F875] to [F879] (Indirect: Up to five)	[6. 1. 6]
43	2BH	Model information reading	Reading of manufacturer, model information, version information, etc.	[6. 1. 7]

(3) DATA (variable length) :Set necessary data (communication number, etc.) with the specified command.

(4) CRC16 (2 bytes) : Set the calculation results of CRC in the order of low and high.
Calculation method of CRC- > Refer to [6. 2 CRC calculation]
Note the order of setting is opposite to those of others.

[Abnormal format]

Blank time for 3.5 bytes	INV-NO	CMD	Error code	CRC16		Blank time for 3.5 bytes
				low	high	
	1byte	Normal command + 80H	Refer to [6. 3 Error code]	1byte	1byte	

6. 1. 1 One word reading command (03H)

- Computer -> inverter * The text size is fixed to 8 bytes.

INV-NO	CMD	Communication number		Number of read words		CRC16	
		high	low	high	low	low	high
	03			00	01		

- (1) INV-NO (1 byte) : -
- (2) CMD (1 byte) : Set the reading command (fixed to 03H)
- (3) Communication number (2 bytes) : Set in the order of high and low.
- (4) Number of read words (2 bytes) : Set the number of words of data 0001H (fixed) in the order of high and low.
- (5) CRC16 (2 bytes) : -

- Inverter -> computer (at normal reply)* The text size is fixed to 7 bytes.

INV-NO	CMD	Number of read bytes	Read data		CRC16	
			high	low	low	high
	03	02				

- (1) INV-NO (1 byte) : -
- (2) CMD (1 byte) : The reading command (fixed to 03H) is returned.
- (3) Number of read bytes (1 byte) : The number of bytes of read data (fixed to 02H) is returned.
- (4) Read data (2 bytes) : Read data, high, and low are returned in this order.
- (5) CRC16 (2 bytes) : -

- Inverter -> computer (at abnormal reply)* The text size is fixed to 5 bytes.

INV-NO	CMD	Error code	CRC16	
			low	high
	83			

- (1) INV-NO (1 byte) : -
- (2) CMD (1 byte) : Fixed to 83H (reading command error) (command + 80H)
- (3) Error code (1 byte) : - > Refer to [6. 3 Error code]
- (4) CRC16 (2 bytes) : -

Concrete example: Reading of output frequency (during operation in 60 Hz)

(Computer -> inverter) 01 03 FD 00 00 01 B5 A6

(Inverter -> computer) 01 03 02 17 70 B6 50

Concrete example: Data error (the number of read words is not 1)

(Computer -> inverter) 01 03 FD 00 00 02 F5 A7

(Inverter -> computer) 01 83 03 01 31

6. 1. 2 Block reading command: Indirect reading (03H)

Set data that is read during block communication in [F875: Block read data 1] to [F879: Block read data 5]. The settings of these parameters are reflected after reset of power off, etc. After setting, reset the power once.

Number	Block read data	Reference of details of data
0	Disabled	-
1	FD01 (Status information)	Refer to [9. 2 Monitor through communication]
2	FD00 (Output frequency)	
3	FD03 (Output current)	
4	FD05 (Output voltage)	Refer to [10. Parameter data]
5	FC91 (Alarm information)	Refer to [9. 2 Monitor through communication]

Number	Block read data	Reference of details of data
6	FD22 (PID feedback value)	Refer to [10. Parameter data]
7	FD06 (Input terminal monitor)	Refer to [9. 2 Monitor through communication]
8	FD07 (Output terminal monitor)	
9	FE35 (Terminal RR monitor)	
10	FE36 (Terminal RX monitor)	
11	FE37 (Terminal II monitor)	
12	FD04 (Input voltage (DC detection))	
13	FD16 (Speed feedback frequency)	
14	FD18 (Torque)	
15	FE60 (My function output monitor 1)	-
16	FE61 (My function output monitor 2)	
17	FE62 (My function output monitor 3)	
18	FE63 (My function output monitor 4)	
19	0880 (Free memorandum)	Refer to [8. 5 Free memorandum ([F880])]
20	FD90 (Motor speed)	Refer to [9. 2 Monitor through communication]
21	FD29 (Input power)	Refer to [10. Parameter data]
22	FD30 (Output power)	
23	FC90 (Trip information)	Refer to [9. 2 Monitor through communication]

* With "9: FE35 (Terminal RR monitor)", "10: FE36 (Terminal RX monitor)", and "11: FE37 (Terminal II monitor)", the data becomes retained data at the time of a trip. With others, the data becomes real-time data.

* If the parameter is set to "0: Disabled", when you specify reading, "0000" is returned as dummy data.

■ Computer -> inverter * The text size is fixed to 8 bytes.

INV-NO	CMD	Communication number		Number of read words		CRC16	
		high	low	high	low	low	high
	03	18	75	00	02-05		

- (1) INV-NO (1 byte) : -
- (2) CMD (1 byte) : Set the reading command (fixed to 03H)
- (3) Communication number (2 bytes) : Set 1875H (fixed).
- (4) Number of read words (2 bytes) : Set the number of words of data 0002 - 0005 in the order of high and low.
- (5) CRC16 (2 bytes) : -

- Inverter -> computer (at normal reply)* The text size varies depending on the number of read data.

INV-NO	CMD	Number of read bytes	Read data 1		...	Read data 5		CRC16	
			low	high		high	low	low	high
	03	04-10							

- (1) INV-NO (1 byte) : -
- (2) CMD (1 byte) : The reading command (fixed to 03H) is returned.
- (3) Number of read bytes (1 byte) : The number of bytes of read data (04H - 10H) is returned.
- (4) Read data 1 (2 bytes) : The data selected in [F875] is read out.
- (5) Read data 2 (2 bytes) : The data selected in [F876] is read out.
- (6) Read data 3 (2 bytes) : The data selected in [F877] is read out.
- (7) Read data 4 (2 bytes) : The data selected in [F878] is read out.
- (8) Read data 5 (2 bytes) : The data selected in [F879] is read out.
- (9) CRC16 (2 bytes) : -

- Inverter -> computer (at abnormal reply)* The text size is fixed to 5 bytes.

INV-NO	CMD	Error code	CRC16	
			low	high
	83			

- (1) INV-NO (1 byte) : -
- (2) CMD (1 byte) : Fixed to 83H (reading command error) (command + 80H)
- (3) Error code (1 byte) : -> Refer to [6. 3 Error code]
- (4) CRC16 (2 bytes) : -

Concrete example: Block reading of five words (during operation in 60 Hz)

<Title of parameter>

- [F802: Inverter number (RS485 common)] = "1"
- [F807: RS485 (1) protocol] or [F827: RS485 (2) protocol] = "1: MODBUS "
- [F875: Block read data 1] = "1: FD01 (Status information)"
- [F876: Block read data 2] = "2: FD00 (Output frequency)"
- [F877: Block read data 3] = "3: FD03 (Output current)"
- [F878: Block read data 4] = "4: FD05 (Output voltage)"
- [F879: Block read data 5] = "5: FC91 (Alarm information)"

(Computer -> inverter) 01 03 18 75 00 05 92 B3
 (Inverter -> computer) 01 03 0A E4 04 17 70 00 00 26 FF 00 80 58 00

Concrete example: Block reading of two words (during operation in 60 Hz, [F875] = "1", [F876] = "2")

(Computer -> inverter) 01 03 18 75 00 02 D3 71
 (Inverter -> computer) 01 03 04 E4 04 17 70 83 16

Concrete example: Block reading of two words (during operation in 60 Hz, [F875] = "0", [F876] = "2")

(Computer -> inverter) 01 03 18 75 00 02 D3 71

(Inverter -> computer) 01 03 04 00 00 17 70 F4 27

Concrete example: Data error (the number of read words is larger than the limit)

(Computer -> inverter) 01 03 18 75 00 06 D2 B2

(Inverter -> computer) 01 83 03 01 31

Concrete example: Data error (the communication number is not 1875H)

(Computer -> inverter) 01 03 18 76 00 02 23 71

(Inverter -> computer) 01 83 03 01 31

6. 1. 3 Block reading command: Direct reading (03H)

Data of successive communication numbers is read from the specified communication number. The address to be read out varies depending on the setting of [F830: MODBUS (Continuous address)].

 Important	<ul style="list-style-type: none"> If no communication number exists, data is returned with 8000H, however, the setting range may be 8000H or more sometimes. Therefore, check that there is no problem with the monitor and the range of parameters to be read with this command.
---	---

[F830] Setting range	Description
0 (Default setting)	Communication numbers "XXXAH" - "XXXFH" and "XXAXH" - "XXFXH" do not exist in VF-AS3, so they are skipped automatically. Example: When two words are read from acceleration time (ACC), the following parameters are read out. Acceleration time (ACC) 0009H Deceleration time (dEC) 0010H
1	All the continuous addresses are accessed regardless of existence of parameters. Example: When two words are read from acceleration time (ACC), the following parameters are read out. Acceleration time (ACC) 0009H No parameter 000AH

■ Computer -> inverter * The text size is fixed to 8 bytes.

INV-NO	CMD	Communication number		Number of read words		CRC16	
		high	low	high	low	low	high
	03			00	02-08		

- (1) INV-NO (1 byte) : -
- (2) CMD (1 byte) : Set the reading command (fixed to 03H)

- (3) Communication number (2 bytes) : Set in the order of high and low.
 Note) When an address that does not exist is set, an error is returned regardless of the number of read words.
- (4) Number of read words (2 bytes) : Set the number of words of data 0002 - 0008 in the order of high and low.
- (5) CRC16 (2 bytes) : -

■ Inverter -> computer (at normal reply)* The text size varies depending on the number of read data.

INV-NO	CMD	Number of read bytes	Read data 1		...	Read data 8		CRC16	
			low	high		high	low	low	high
	03	04-16							

- (1) INV-NO (1 byte) : -
- (2) CMD (1 byte) : The reading command (fixed to 03H) is returned.
- (3) Number of read bytes (1 byte) : The number of bytes of read data (04H - 10H) is returned.
- (4) Read data 1 (2 bytes) : The data of the specified communication number is read out.
- (5) Read data 2 (2 bytes) : The data of the specified (communication number + 1) is read out.
- (6) Read data 3 (2 bytes) : The data of the specified (communication number + 2) is read out.
- (7) Read data 4 (2 bytes) : The data of the specified (communication number + 3) is read out.
- (8) Read data 5 (2 bytes) : The data of the specified (communication number + 4) is read out.
- (9) Read data 6 (2 bytes) : The data of the specified (communication number + 5) is read out.
- (10) Read data 7 (2 bytes) : The data of the specified (communication number + 6) is read out.
- (11) Read data 8 (2 bytes) : The data of the specified (communication number + 7) is read out.
- (12) CRC16 (2 bytes) : -

■ Inverter -> computer (at abnormal reply)* The text size is fixed to 5 bytes.

INV-NO	CMD	Error code	CRC16	
			low	high
	83			

- (1) INV-NO (1 byte) : -
- (2) CMD (1 byte) : Fixed to 83H (reading command error) (command + 80H)
- (3) Error code (1 byte) : - > Refer to [6. 3 Error code]
- (4) CRC16 (2 bytes) : -

Concrete example: Block reading of five blocks from [F100] (communication number: 0100)



<Title of parameter>

- [F802: Inverter number (RS485 common)] = "1"
- [F807: RS485 (1) protocol] or [F827: RS485 (2) protocol] = "1: MODBUS "
- [F100: Low-speed signal output frequency] = "1.0 (Hz)" (= 0064H)
- [F101: Reach signal specified frequency] = "60.0 (Hz)" (= 1770H)
- [F102: Reach signal detection band] = "2.5 (Hz)" (= 00FAH)
- [F103]: A parameter that does not exist (= 8000H)
- [F104]: A parameter that does not exist (= 8000H)

(Computer -> inverter) 01 03 01 00 00 05 84 35

(Inverter -> computer) 01 03 0A 00 64 17 70 00 FA 80 00 80 00 1F 4D

6. 1. 4 Word writing command (06H/10H)

 Caution	
 Mandatory action	<ul style="list-style-type: none"> • Writing of parameters to EEPROM should be executed within 100000 times. EEPROM has a life that expires with writing of approx. 100000 times. In addition, since command parameters (There are some exceptions -> Refer to command parameters of [10. Parameter data]) have only RAM and no EEPROM, the number of times is not limited. • If Toshiba inverter protocol is used and data does not need to be stored, writing only to RAM (using P command) is possible.

(1) Word writing command (06H)

- Computer -> inverter * The text size is fixed to 8 bytes.

INV-NO	CMD	Communication number		Write data		CRC16	
		high	low	high	low	low	high
	06						

- (1) INV-NO (1 byte) : -
- (2) CMD (1 byte) : Set the writing command (fixed to 06H).
- (3) Communication number (2 bytes) : Set in the order of high and low.
- (4) Write data (2 bytes) : Set in the order of write data, high and low.
- (5) CRC16 (2 bytes) : -

- Inverter -> computer (at normal reply)* The text size is fixed to 8 bytes.
The packet same as at the time of receiving is returned to the computer.

INV-NO	CMD	Communication number		Write data		CRC16	
		high	low	high	low	low	high
	06						

- Inverter -> computer (at abnormal reply)* The text size is fixed to 5 bytes.

INV-NO	CMD	Error code	CRC16	
			low	high
	86			

- (1) INV-NO (1 byte) : -
- (2) CMD (1 byte) : Fixed to 86H (writing command error) (command + 80H)
- (3) Error code (1 byte) : - > Refer to [6. 3 Error code]
- (4) CRC16 (2 bytes) : -

Concrete example: Writing to frequency command value (FA01) (60Hz)

(Computer -> inverter) 01 06 FA 01 17 70 E6 C6

(Inverter -> computer) 01 06 FA 01 17 70 E6 C6

Concrete example: Communication number error (no communication number exists)

(Computer -> inverter) 01 06 FF FF 00 00 89 EE

(Inverter -> computer) 01 86 02 C3 A1

6

(2) Word writing command (10H)

- Computer -> inverter * The text size is fixed to 11 bytes.

INV-NO	CMD	Communication number		Number of write words		Number of write bytes	Write data		CRC16	
		high	low	high	low		high	low	low	high
	10			00	01	02				

- (1) INV-NO (1 byte) : -
- (2) CMD (1 byte) : Set 10H (fixed).
- (3) Communication number (2 bytes) : Set in the order of high and low.
- (4) Number of write words (2 bytes) : Set 0001H (fixed).
- (5) Number of write bytes (1 bytes) : Set 02H (fixed).
- (6) Write data (2 bytes) : Set in the order of write data, high and low.
- (7) CRC16 (2 bytes) : -

- Inverter -> computer (at normal reply)* The text size is fixed to 8 bytes.

INV-NO	CMD	Communication number		Number of write words		CRC16	
		high	low	high	low	low	high
	10			00	01		

- (1) INV-NO (1 byte) : -
- (2) CMD (1 byte) : The block writing command (fixed to 10H) is returned.
- (3) Communication number (2 bytes) : High and low are returned in this order.
- (4) Number of write words (2byte) : 0001H (fixed) is returned.

(5) CRC16 (2 bytes) : -

- Inverter -> computer (at abnormal reply)* The text size is fixed to 5 bytes.

INV-NO	CMD	Error code	CRC16	
			low	high
	90			

- (1) INV-NO (1 byte) : -
- (2) CMD (1 byte) : Fixed to 90H (writing command error) (command + 80H)
- (3) Error code (1 byte) : - > Refer to [6. 3 Error code]
- (4) CRC16 (2 bytes) : -

Concrete example: Writing to frequency command value (FA01) (60Hz)

(Computer -> inverter) 01 10 FA 01 00 01 02 17 70 F3 9A

(Inverter -> computer) 01 10 FA 01 00 01 60 D1

6. 1. 5 Block writing command: Indirect writing (10H)

Set data that is written with block communication in [F870: Block write data 1] or [F871: Block write data 2]. The settings of these parameters are reflected after reset of power off, etc. After setting, reset the power once.

Number	Block write data	Reference of details of data
0	Disabled	-
1	FA00 (Communication command 1)	Refer to [9. 1 Command through communication]
2	FA20 (Communication command 2)	
3	FA01 (Frequency command)	
4	FA50 (TB output)	
5	FA51 (Analog output)	
6	FA13 (Speed command by communication)	

* If the parameter is set to "0: Disabled", writing is not performed even if write data is specified.

- Computer -> inverter * The text size is fixed to 13 bytes.

INV-NO	CMD	Communication number		Number of write words		Number of write bytes	Write data 1		Write data 2		CRC16	
		high	low	high	low		high	low	high	low	low	high
	10	18	70	00	02	04						

- (1) INV-NO (1 byte) : -
- (2) CMD (1 byte) : Set the block writing command (fixed to 10H).

- (3) Communication number (2 bytes) : Set 1870H (fixed).
- (4) Number of write words (2 bytes) : Set 0002H (fixed).
- (5) Number of write bytes (1 byte) : Set 04H (fixed).
- (6) Write data 1 (2 bytes) : Set in the order of write data, high and low. It is write data to information set in [F870].
- (7) Write data 2 (2 bytes) : Set in the order of write data, high and low. It is write data to information set in [F871].
- (8) CRC16 (2 bytes) : -

■ Inverter -> computer (at normal reply)* The text size is fixed to 8 bytes.

INV-NO	CMD	Communication number		Number of write words		CRC16	
		high	low	high	low	low	high
	10	18	70	00	02		

- (1) INV-NO (1 byte) : -
- (2) CMD (1 byte) : The block writing command (fixed to 10H) is returned.
- (3) Communication number (2 bytes) : 1870H (fixed) is returned.
- (4) Number of write words (2 bytes) : 0002H (fixed) is returned.
- (5) CRC16 (2 bytes) : -

■ Inverter -> computer (at abnormal reply)* The text size is fixed to 5 bytes.

INV-NO	CMD	Error code	CRC16	
			low	high
	90			

- (1) INV-NO (1 byte) : -
- (2) CMD (1 byte) : Fixed to 90H (reading command error) (command + 80H)
- (3) Error code (1 byte) : - > Refer to [6. 3 Error code]
- (4) CRC16 (2 bytes) : -

Concrete example: Block writing (forward run and 60 Hz run command)

<Title of parameter>

[F802: Inverter number (RS485 common)] = "1"

[F807: RS485 (1) protocol] or [F827: RS485 (2) protocol] = "1: MODBUS"

[F870: Block write data 1] = "1: FA00 (Communication command 1)"

[F871: Block write data 2] = "3: FA01 (Frequency command)"

Note) If communication priority bits (FA00: Bits 14 and 15 of communication command 1) are not set, settings of [CMOd: Run command select] = "3: RS485 communication (connector 1)" and [FM0d: Frequency command select 1] = "21: RS485 communication (connector 1)" are required.

(Computer -> inverter) 01 10 18 70 00 02 04 C4 00 17 70 6D AF

(Inverter -> computer) 01 10 18 70 00 02 46 B3

Concrete example: Abnormal reply (parameters are not set, [F870] = "0", [F871] = "0")

(Computer -> inverter) 01 10 18 70 00 02 04 C4 00 17 70 6D AF

(Inverter -> computer) 01 90 04 4D C3

Concrete example: Data error (the communication number is not 1870H)

(Computer -> inverter) 01 10 18 71 00 02 04 C4 00 17 70 AC 63

(Inverter -> computer) 01 90 03 0C 01

Concrete example: Data error (the number of write bytes is not 4)

(Computer -> inverter) 01 10 18 70 00 02 03 C4 00 17 70 D8 6F

(Inverter -> computer) 01 90 03 0C 01

6. 1. 6 Block writing and reading command: Indirect writing and reading (17H)

Block writing and reading are executed in one communication.

Set the data to be written at the time of block communication in [F870: Block write data 1] or [F871: Block write data 2] and the data contents to be read out at the time of block communication in [F875: Block read data 1] to [F879: Block read data 5]. The settings of these parameters are reflected after reset of power off, etc. After setting, reset the power once.

6

Number	Block write data	Reference of details of data
0	Disabled	-
1	FA00 (Communication command 1)	Refer to [9. 1 Command through communication]
2	FA20 (Communication command 2)	
3	FA01 (Frequency command)	
4	FA50 (TB output)	
5	FA51 (Analog output)	
6	FA13 (Speed command by communication)	

* If the parameter is set to "0: Disabled", writing is not performed even if write data is specified.

Number	Block read data	Reference of details of data
0	Disabled	-
1	FD01 (Status information)	Refer to [9. 2 Monitor through communication]
2	FD00 (Output frequency)	
3	FD03 (Output current)	
4	FD05 (Output voltage)	Refer to [10. Parameter data]
5	FC91 (Alarm information)	Refer to [9. 2 Monitor through communication]
6	FD22 (PID feedback value)	Refer to [10. Parameter data]

Number	Block read data	Reference of details of data
7	FD06 (Input terminal monitor)	Refer to [9. 2 Monitor through communication]
8	FD07 (Output terminal monitor)	
9	FE35 (Terminal RR monitor)	
10	FE36 (Terminal RX monitor)	
11	FE37 (Terminal II monitor)	
12	FD04 (Input voltage (DC detection))	
13	FD16 (Speed feedback frequency)	Refer to [9. 2 Monitor through communication]
14	FD18 (Torque)	
15	FE60 (My function output monitor 1)	-
16	FE61 (My function output monitor 2)	
17	FE62 (My function output monitor 3)	
18	FE63 (My function output monitor 4)	
19	0880 (Free memorandum)	Refer to [8. 5 Free memorandum ([F880])]
20	FD90 (Motor speed)	Refer to [9. 2 Monitor through communication]
21	FD29 (Input power)	Refer to [10. Parameter data]
22	FD30 (Output power)	
23	FC90 (Trip information)	Refer to [9. 2 Monitor through communication]

* With "9: FE35 (Terminal RR monitor)", "10: FE36 (Terminal RX monitor)", and "11: FE37 (Terminal II monitor)", the data becomes retained data at the time of a trip. With others, the data becomes real-time data.

* If the parameter is set to "0: Disabled", when you specify reading, "0000" is returned as dummy data.

■ Computer -> inverter * The text size is fixed to 17 bytes.

INV-NO	CMD	Read communication number		Number of read words		Write communication number		Number of write words	
		high	low	high	low	high	low	low	high
	17	18	75	00	02-05	18	70	00	02

Number of write bytes	Write data 1		Write data 2		CRC16	
	high	low	high	low	low	high
04						

(1) INV-NO (1 byte)

: -

(2) CMD (1 byte)

: Set the command (fixed to 17H).

- (3) Read communication number (2 bytes) : Set 1875H (fixed).
- (4) Number of read words (2 bytes) : Set the number of words of data 0002 - 0005 in the order of high and low.
- (5) Write communication number (2 bytes) : Set 1870H (fixed).
- (6) Number of write words (2 bytes) : Set 0002H (fixed).
- (7) Number of write bytes (1 byte) : Set 04H (fixed).
- (8) Write data 1 (2 bytes) : Set in the order of write data, high and low. It is write data to information set in [F870].
- (9) Write data 2 (2 bytes) : Set in the order of write data, high and low. It is write data to information set in [F871].
- (10) CRC16 (2 bytes) : -

■ Inverter -> computer (at normal reply)* The text size varies depending on the number of read data.

INV-NO	CMD	Number of read bytes	Read data 1		...	Read data 5		CRC16	
			low	high		high	low	low	high
	17	04-10							

- (1) INV-NO (1 byte) : -
- (2) CMD (1 byte) : The writing and reading command (fixed to 17H) is returned.
- (3) Number of read bytes (1 byte) : The number of bytes of read data (04H - 10H) is returned.
- (4) Read data 1 (2 bytes) : The data selected in [F875] is read out.
- (5) Read data 2 (2byte) : The data selected in [F876] is read out.
- (6) Read data 3 (2byte) : The data selected in [F877] is read out.
- (7) Read data 4 (2byte) : The data selected in [F878] is read out.
- (8) Read data 5 (2byte) : The data selected in [F879] is read out.
- (9) CRC16 (2 bytes) : -

■ Inverter -> computer (at abnormal reply)* The text size is fixed to 5 bytes.

INV-NO	CMD	Error code	CRC16	
			low	high
	97			

- (1) INV-NO (1 byte) : -
- (2) CMD (1 byte) : Fixed to 97H (writing and reading command error) (command + 80H)
- (3) Error code (1 byte) : - > Refer to [6. 3 Error code]
- (4) CRC16 (2 bytes) : -

6. 1. 7 Model information reading command (2BH)

- Computer -> inverter * The text size is fixed to 7 bytes.

INV-NO	CMD	MEI type	Reading equipment code	Object code	CRC16	
					low	high
	2B (fixed)	0E (fixed)	00-03 (variable)	00		

- (1) INV-NO (1 byte) : -
- (2) CMD (1 byte) : Set the model information reading command (fixed to 2BH).
- (3) MEI type (1 byte) : Set OEH (fixed).
- (4) Reading equipment code (1 byte) : Set 00 - 03H.
- (5) Object code (1 byte) : Set 00H.
- (6) CRC16 (2 bytes) : -

- Inverter -> computer * The text size has variable length.

INV-NO	CMD	MEI type	Reading equipment code	Conformity level	Extended frame number	Next object code	Number of objects
(variable)	2B (fixed)	0E (fixed)	00-03 (variable)	01 (fixed)	00 (fixed)	00 (fixed)	03 (fixed)

Object 1 code	Object 1 code length	Object 1 information
00 (fixed)	07 (fixed)	"TOSHIBA" (fixed)
Object 2 code	Object 2 code length	Object 2 information
01 (fixed)	0B (variable)	"VFAS3-2037P" Note) Appendix 3 (variable)
Object 3 code	Object 3 code length	Object 3 information
02 (fixed)	04 (fixed)	"0100" (variable)
CRC16		
low	high	
(variable)	(variable)	

The three pieces of object information are as follows.

Object 1 information: Manufacturer information Example: "TOSHIBA"

Object 2 information: Model information Example: "VFAS3-2037PM"

Note) Inverter model information
-> Refer to [A3]

Object 3 information: Version information Example: "0100" means version 100.

Concrete example: Inverter number = 01H, "TOSHIBA", "VFAS3-2037P", "0100"

```

(Computer -> inverter)    01 2B 0E 01 00 70 77
(Inverter -> computer)   01 2B 0E 01 01 00 00 03
                          00 07 54 4F 53 48 49 42 41
                          01 0B 56 46 41 53 33 2D 32 30 33 37 50
                          02 04 30 31 30 30
                          52 10
    
```

- Inverter -> computer (at abnormal reply)* The text size is fixed to 5 bytes.

INV-NO	CMD	Error code	CRC16	
			low	high
	AB			

- (1) INV-NO (1 byte) : -
- (2) CMD (1 byte) : Fixed to ABH (reading error) (command + 80H)
- (3) Error code (1 byte) : - > Refer to [6. 3 Error code]
- (4) CRC16 (2 bytes) : -

6.2 CRC calculation

CRC is a system to check if the communication frame has an error at the time of data transmission. CRC has 2-byte configuration and consists of 16-bit binary values. The CRC value is calculated on the transmission side where CRC is added to the message. The receiving side recalculates the CRC of the received message and compares the calculation result with the CRC value actually received. If the values do not match, data is discarded.

■ Flow

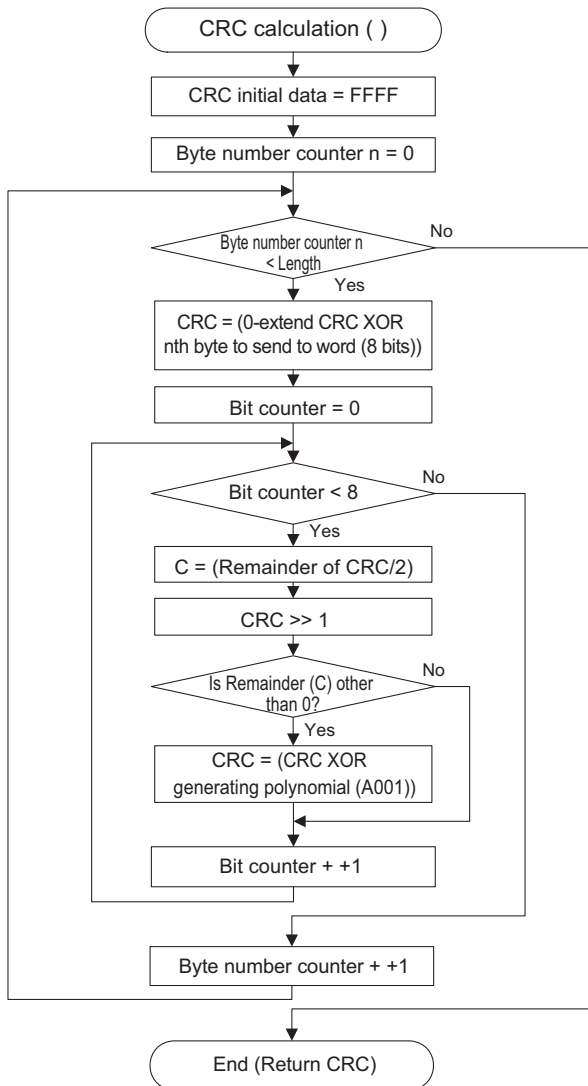

CRC calculation procedure:

1. Set 16-bit data (FFFFH) in which all the values are "1" to the 16-bit register as default setting.
2. Obtain the exclusive OR with the 16-bit register for CRC and n-th 1 byte of the message (use only the lower 8 bits and extend the upper 8 bits with 0). When generating CRC, use only 8 bits of each character. The start, stop, and parity bits are not applied to CRC.
3. Shift the register for CRC toward the least significant bit (LSB) by 1 bit. Then, set zero for the most significant bit. (MSB). Extract the least significant bit (LSB) to check.
4. When the least significant bit (LSB) is 0
-> Repeat step 3.
When the least significant bit (LSB) is 1
-> Obtain the exclusive OR with the register for CRC and the polynomial value A001H (1010 0000 0000 0001).
5. Repeat 3 and 4 until shift is performed eight times (8 bits).
When this is completed, 1 byte (8 bits) has been processed.
6. Repeat step 2 - 5 for 8 bits of the next message, too. Repeat this until all the bytes have been processed.
7. The CRC value is the contents of the register for CRC after applied to all the bytes in the message.
8. When CRC is added to the message, the lower byte is added first, and then the upper byte.

6.3 Error code

If the following errors occur, the reply command from the inverter is returned by adding 80H to the command received by the inverter.

Error code	Name	Description
01	Command error	<ul style="list-style-type: none"> No command exists. The MEI type is not 14 (0EH) with the model information reading command 43.
02	Communication number error	<ul style="list-style-type: none"> No communication number exists. Writing was performed to the exclusive reading parameter.
03	Data error	<ul style="list-style-type: none"> Data range error Communication format error When the reading equipment code is set to 4 or more in the model information reading command.
04	Execution impossible	<ul style="list-style-type: none"> Writing to a parameter that is impossible to be written while running Writing to a parameter for which [tyP] is being executed Writing when [F700: Parameter reading&writing access lockout] is set to "2: Writing locked (1 + RS485 communication)" or "4: Reading&Writing locked (3 + RS485 communication)" Writing to [F738] when [F738: Password setting] is set.

7 Inverter-to-inverter communication ([F806] or [F826])

Inverter-to-inverter communication can be used to implement speed-proportional control between multiple inverters without using a PLC or a computer. Commands are input to the leader inverter via the operation panel or analog signal.

When the inverter-to-inverter communication function is used, the leader inverter keeps sending data selected by parameters to all child inverters on the same network. The leader uses S commands for commands to the followers. The followers do not respond with data (-> Refer to [5. 2 Transmission command]). You can configure a network using this function to perform simple synchronized operation or speed proportional operation.

- * When the leader trips, the "t" alarm blinks on the followers, and the followers stop with 0 Hz frequency. When the leader trip is cleared, the followers are restored as well. For details, refer to the leader/follower setting ([F806] or [F826]) during inverter-to-inverter communication on the next page.
- * To select how the followers operate when cable is disconnected or the leader is turned off (continue/alarm/trip), use the communication time-out detection function ([F803], [F804], and [F808], or [F823], [F824], and [F828]).
- * To use this function, set [F807: RS485 (1) protocol] or [F827: RS485 (2) protocol] to "0: TOSHIBA". In the default setting, both [F807] and [F827] are set to "0: TOSHIBA."-> Refer to [4. Selecting communication protocol]

<Communication connection schematic diagram (example)>

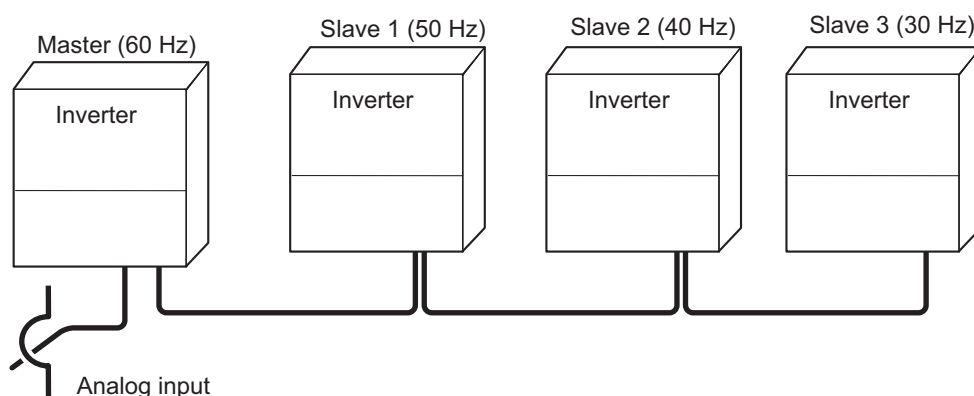



Important

- Although this function is able to send speed commands, it does not send run/stop signals. Therefore, you must set run/stop signal for each follower or set a parameter that is able to stop the unit based on frequency ([F241: Run frequency], [F242: Run frequency hysteresis]). In case communication cables are broken, the followers continue running based on the last received command value. *By using the communication time-out detection function ([F803], [F804], and [F808], or [F823], [F824], and [F828]), you can trip a follower inverter with broken communication cable. The leader will not trip even if its cable is broken. To trip it, install an interlock from the follower side using an FL failure relay signal, etc.

■ Wiring

To use 4-wire RS485 on RS485 communication connector 2, you need to set [F829: RS485 (2) wiring type] to "1: 4-wire".

Wiring details -> Refer to [3]

■ Parameter setting

● Protocol setting ([F807] or [827])...Default setting = "0: TOSHIBA"

Set "0: TOSHIBA" for all inverters (both leader and followers) using inverter-to-inverter communication.

* Inverter-to-inverter communication is not available when the MODBUS-RTU protocol is set.

* These parameters are reflected after resetting the inverter or turning the inverter power off and then on.

● Inverter-to-inverter communication selection ([F806] or [F826]) ... Default setting = "0"

Set only one inverter on the network as leader and all others as followers.

* If multiple leaders are set on the same network, data conflict will occur. Be sure to only set one leader.

Setting for the leader inverter

Set the data to be set from the leader to the followers.

3: Leader (transmit frequency command)

4: Leader (transmit output frequency signal)

5: Leader (transmit torque command)

6: Leader (transmit output torque command)

Setting for the follower inverters

Set the operation of the follower side when the leader trips.

0: Follower (0 Hz command when Leader fails) (Use only when [F806] or [F826] is set to "3" or "4".)

(Note that output frequency is limited by the lower limit frequency.)

1: Follower (continue running when Leader fails)

Note) When an output frequency is set on the leader, the trip causes the output frequency of the leader to change to 0 Hz. In this case, the frequency command to the followers will be 0 Hz.

2: Follower (emergency off when Leader fails)

The stop pattern follows the [F603: Emergency off stop pattern] settings.

- * These parameters are reflected after resetting the inverter or turning the inverter power off and then on.
- * If [F809: Operation panel connection priority] is set to "1: Connect to connector 1", the setting of [F806] is disabled. If [F809] is set to "2: Connect to connector 2", the setting of [F826] is disabled.

- **Transmission wait time ([F805] or [F825]) ... Default setting = "0.00"**

- **Setting for the leader inverter**

- Set this value when you want to delay commands sent to the followers.

- **Frequency command select 1 ([FMOd]) ... Default setting = "1: Terminal RR"**

- For [FMOd], set the input that gives frequency commands to the inverter.

- **Setting for the leader inverter**

- Set a value for a communication means other than RS485 ([FMOd] ≠ "21" or "22").

- **Setting for the follower inverters**

- Set a value for RS485 communication ([FMOd] = "21" or "22").

- **Related communication parameters**

- Set the following parameters as necessary.

- **Baud rate ([F800][F820]) ... Default setting = "1: 19200 bps"**

- Set the same baud rate for all inverters (leader and followers) on the network.

- **Parity ([F801][F821]) ... Default setting = "1: Even parity"**

- Set the same parity for all inverters (leader and followers) on the network.

- **Communication time-out time ([F803][F823])... Default setting = "0.0: Disabled"**

- In case communication cables are broken, the followers continue running based on the last received command value. To stop the inverter, set the communication time-out time to the followers (for example, [F803] or [F823] = "1.0 (s)").

- The leader will not trip even if its cable is broken. To trip it, install interlocking from the followers using an FL failure relay signal, etc.

- **Transmission wait time ([F805][F825])**

- If response times from the followers vary, the transmission interval of the leader may be too short. In this case, set [F805] or [F825] to "0.01 (s)."

- **Frequency point conversion ([F810], [F811] to [F814])**

- Adjust the values according to your system.

- Details -> Refer to [7. 1 Speed proportional control ([F810] to [F814])]

■ Parameter setting examples for RS485 (2) (4-wire)

Parameters of the leader (examples)

[F826] = "3"	Frequency command (100% = Maximum frequency)
[F827] = "0"	Communication protocol setting (TOSHIBA inverter protocol)
[F820] = "1"	Baud rate (Example: 19200 bps)
[F821] = "1"	Parity (Even)
[CMOd] = "1"	Example: Panel
[FMOd] = "1"	Example: Terminal RR
[F825] = "0.01"	Transmission wait time
[F829] = "1"	4-wire

Parameters of the followers (examples)

[F826] = "0"	Follower (Stop the follower when the Leader trips)
[F827] = "0"	Communication protocol setting (TOSHIBA inverter protocol)
[F823] = "1"	Communication time-out time (Example: 1 second)
[F820] = "1"	Baud rate (Same as Leader)
[F821] = "1"	Parity (Same as Leader)
[CMOd] = "0"	Terminal (Example: Run using [F] and [ST] terminals) (The inverter can be run or stopped with a frequency command by setting [F241: Run frequency].)
[FMOd] = "22"	RS485 communication connector 2
[F810] = "1"	Frequency point select Enabled
[F811] = "?"	Adjust the values according to your system Point 1 input value (%)
[F812] = "?"	Same as above Point 1 frequency (Hz)
[F813] = "?"	Same as above Point 2 input value (%)
[F814] = "?"	Same as above Point 2 frequency (Hz)
[F829] = "1"	4-wire

7.1 Speed proportional control ([F810] to [F814])

Two kinds of frequency proportional control methods are available (frequency point selection, percentage against maximum frequency). Although the description in this section is based on inverter-to-inverter communication, you can use proportional operation with S commands during computer-linked communication. In this case, substitute "leader" in the description with "computer".

In addition, you can use proportional operation by the unit of Hz using normal write commands (W and P commands). In this case, only frequency point selection is available. For proportional operation using percentages, use the S command.

* Proportional control with frequency point selection allows various inclination settings depending on usage. In contrast, proportional control with percentage against maximum frequency is simple. You can complete the setting without regarding acceleration/deceleration toward the target frequency value.

- **Details of transmitted data during inverter-to-inverter communication (frequency command value)**

$$f_c (\%) = \frac{\text{Master frequency command value} \times 10000}{\text{Master maximum frequency}} \quad (1 = 0.01\%)$$

* Calculation results of 1 (0.01%) or less are rounded down. As a result, a maximum error of 0.01% occurs.

- **Conversion details of frequency commands after they are received by followers (when frequency points are not selected)**

The value after conversion below is written to the RAM as a frequency command value.

$$f_c (\text{Hz}) = \frac{\text{Reception data} (\%) \times \text{Slave maximum frequency}}{10000} \quad (1 = 0.01 \text{ Hz})$$

* Calculation results of 1 (0.01 Hz) or less are rounded down. As a result, a maximum error of 0.01 Hz occurs.

Speed proportional control diagram

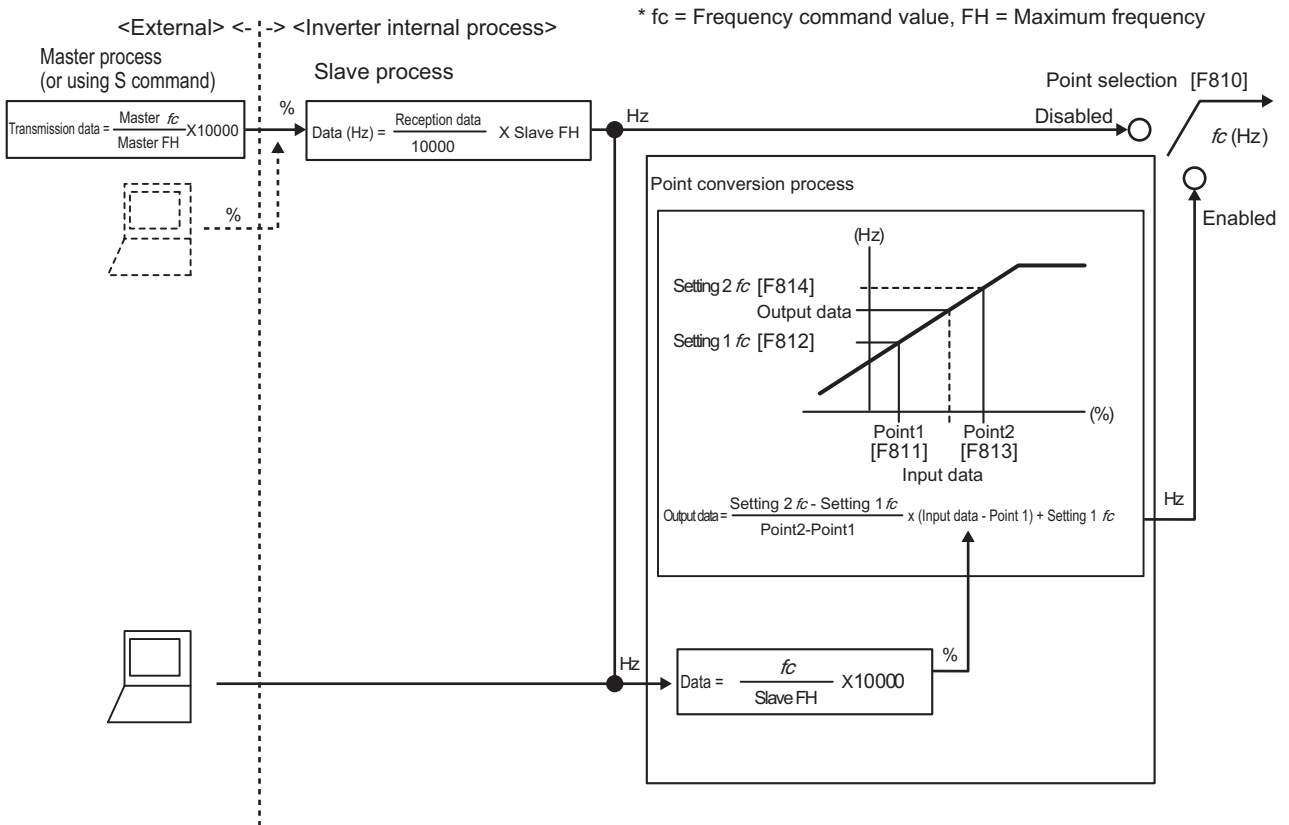

• **When frequency point selection is disabled ([F810] = "0")**

The result of the following expression becomes the frequency command value for the inverter. During inverter-to-inverter communication, "received data" in the formula stands for data sent from the leader. During computer link, "received data" in the formula stands for data sent from a computer.

$$f_c (\text{Hz}) = \frac{\text{Reception data} (\%) \times \text{Slave maximum frequency}}{10000} (\text{Hz})$$

(Example)

Unit: 1 = 0.01 Hz

	Maximum frequency	Frequency command value
Leader (f_c)	100.00 Hz (10000)	50.00 Hz (5000)
Follower 1	90.00 Hz (9000)	45.00 Hz (4500)
Follower 2	80.00 Hz (8000)	40.00 Hz (4000)

$$\text{Master transmission: } f_c (\%) = \frac{\text{Master frequency command value} \times 10000}{\text{Master maximum frequency}} = \frac{5000 \times 10000}{10000} = 5000 = 50\%$$

$$\text{Slave 1: } f_c (\text{Hz}) = \frac{5000 \times 9000}{10000} = 4500 = 45 \text{ Hz}$$

$$\text{Slave 2: } f_c (\text{Hz}) = \frac{5000 \times 8000}{10000} = 4000 = 40 \text{ Hz}$$

• **When frequency point selection is enabled ([F810] = "1", "2")**

In the case of inverter-to-inverter communication, the calculation result of the following expression becomes the frequency command value for the followers.

In the case of computer link, substitute the command from the leader in the following expression with data sent from a computer, etc. and then calculate.

$$f_c (Hz) = \frac{\text{Point 2 frequency} - \text{Point 1 frequency}}{\text{Point 2} - \text{Point 1}} \times (\text{Master command} (\%) - \text{Point 1}) + \text{Point 1 frequency} (Hz)$$

(Example)

Unit: (Frequency unit) 1 = 0.01Hz, (Point setting unit) 1 = 0.01%

	Maximum frequency [FH]	Point 1 input value [F811]	Point 1 frequency [F812]	Point 2 input value [F813]	Point 2 frequency [F814]	Frequency value [FC]
Leader (fc)	100.00Hz (10000)	-	-	-	-	50.00Hz (5000)
Follower 1	100.00Hz (10000)	0.00% (0)	0.00Hz (0)	100.00% (10000)	90.00Hz (9000)	45.00Hz (4500)
Follower 2	100.00 Hz (10000)	0.00% (0)	0.0Hz (0)	100.00% (10000)	80.00Hz (8000)	40.00Hz (4000)

The data sent from the leader is as follows.

$$\text{Master transmission: } f_c (\%) = \frac{\text{Master frequency command value} \times 10000}{\text{Master maximum frequency}} = \frac{5000 \times 10000}{10000} = 5000 = 50\%$$

The result of point conversion process is as follows (see above for expression)

$$\text{Slave 1: } f_c (Hz) = \frac{9000 - 0}{10000 - 0} \times (5000 - 0) + 0 = 4500 = 45 \text{ Hz}$$

$$\text{Slave 2: } f_c (Hz) = \frac{8000 - 0}{10000 - 0} \times (5000 - 0) + 0 = 4000 = 40 \text{ Hz}$$

7.2 Transmission format of inverter-to-inverter communication (reference)

Data format is handled in hex numbers, and character transmission is processed using binary codes (HEX).

The mechanism is basically the same as the binary transmission format. S commands are used and the follower inverters do not respond with data.

- Leader inverter -> Follower inverter (binary mode)

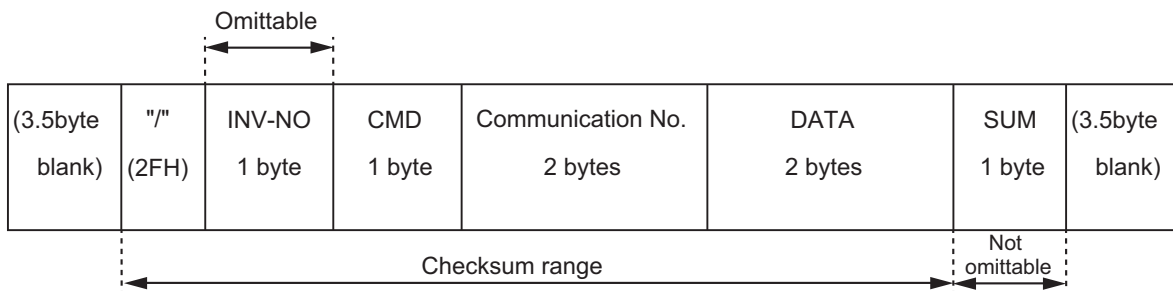

7

1. INV-NO (1 Byte) : Inverter number
This value is always omitted for the leader during inverter-to-inverter communication.
When the function is used for proportional operation, the user can add this data.
(When the data is added, only the corresponding inverter accepts data.)
2. CMD (1 byte) : Command
53H ("S") or 73H ("s") command ... Inverter-to-inverter communication command
If the leader inverter is not tripped, use 53H ("S")
If the leader inverter is tripped, use 73H ("s")
3. Communication number (2 bytes) : For RS485 (1), set "FA01"
For RS485 (2), set "FA05"
4. DATA (2 bytes) : Command data (%) to followers (0 to 10000: 100 = 1%)

S commands -> Refer to [5. 2 Transmission command], inverter-to-inverter communication -> Refer to [7. Inverter-to-inverter communication ([F806] or [F826])]

8

Communication-related parameters

Communication-related parameters can be set from the operation panel or via communication. Note that there are parameters that are reflected immediately after setting and parameters that are reflected after a reset operation such as power off.

Some parameters have fixed values to be used for communication with the LCD operation panel.

Depending on the communication connector used, set [F809: Operation panel connection priority].



Important

- If [F809: Operation panel connection priority] is changed to "0: By the parameter setting", there are cases that the LCD operation panel cannot be connected. In this case, rewrite [F809] via external communication and reset power to enable reconnection.

Communication No.	Title	Parameter name	Adjustment range	Unit	Default setting	Data reflection	MODBUS protocol	Reference
0800	F800	RS485 (1) baud rate	0: 9600bps 1: 19200bps 2: 38400bps	-	1	After reset	Enabled	[8. 1] Note)
0801	F801	RS485 (1) parity	0: Disabled 1: Even parity 2: Odd parity	-	1	After reset	Enabled	[8. 1] Note)
0802	F802	Inverter number (RS485 common)	0 to 247	1	0	Immediately	Enabled	[8. 2]
0803	F803	RS485 (1) time-out time	0.0: Disabled 0.1 to 100.0	0.1s	0.0	Immediately	Enabled	[8. 3]
0804	F804	RS485 (1) time-out operation	1: Continue running 4: Trip 6: Trip after Deceleration stop	-	1	Immediately	Enabled	[8. 3]
0805	F805	RS485 (1) transmission wait time	0.00 to 2.00	0.01s	0.00	Immediately	Enabled	[8. 4]
0806	F806	RS485 (1) inverter-to-inverter communication	0: Follower (0Hz command when Leader fails) 1: Follower (continue running when Leader fails) 2: Follower (emergency off when Leader fails) 3: Leader (transmit frequency command) 4: Leader (transmit output frequency signal) 5: Leader (transmit torque command) 6: Leader (transmit output torque command)	-	0	After reset	Disabled	[Chapter 7] Note)
0807	F807	RS485 (1) protocol	0: TOSHIBA 1: MODBUS	-	0	After reset	Enabled	[Chapter 4]

Communication No.	Title	Parameter name	Adjustment range	Unit	Default setting	Data reflection	MODBUS protocol	Reference
0808	F808	RS485 (1) timeout detection	0: Always 1: Run command and frequency command by communication are enabled. 2: During run by communication	-	1	Immediately	Enabled	[8. 3]
0809	F809	Operation panel connection priority	0: By the parameter setting 1: Connect to connector 1 2: Connect to connector 2	-	1	After reset	Enabled	Note)
0810	F810	Communication frequency point select	0: Disabled 1: RS485 communication (connector 1) 2: RS485 communication (connector 2) 3: Communication option 4. Embedded Ethernet	-	0	Immediately	Enabled	
0811	F811	Communication point 1 Input value	0 to 100	1%	0	Immediately	Enabled	[7. 1]
0812	F812	Communication point 1 Frequency	0.0 to FH	0.01 Hz	0.0	Immediately	Enabled	
0813	F813	Communication point 2 Input value	0 to 100	1%	100	Immediately	Enabled	
0814	F814	Communication point 2 Frequency	0.0 to FH	0.01 Hz	50.0/60.0	Immediately	Enabled	
0820	F820	RS485 (2) baud rate	0: 9600bps 1: 19200bps 2: 38400bps	-	1	After reset	Enabled	[8. 1] Note)
0821	F821	RS485 (2) parity	0: Disabled 1: Even parity 2: Odd parity	-	1	After reset	Enabled	[8. 1] Note)
0823	F823	RS485 (2) time-out time	0.0: Disabled 0.1 to 100.0	0.1s	0.0	Immediately	Enabled	[8. 3]
0824	F824	RS485 (2) time-out operation	1: Continue running 4: Trip 6: Trip after Deceleration stop	-	1	Immediately	Enabled	[8. 3]
0825	F825	RS485 (2) transmission wait time	0.00 to 2.00	0.01s	0.00	Immediately	Enabled	[8. 4]
0826	F826	RS485 (2) inverter-to-inverter communication	0: Follower (0Hz command when Leader fails) 1: Follower (continue running when Leader fails) 2: Follower (emergency off when Leader fails) 3: Leader (transmit frequency command) 4: Leader (transmit output frequency signal) 5: Leader (transmit torque command) 6: Leader (transmit output torque command)	-	0	After reset	Disabled	[Chapter 7]
0827	F827	RS485 (2) protocol	0: TOSHIBA 1: MODBUS	-	0	After reset	Enabled	[Chapter 4]
0828	F828	RS485 (2) time-out detection	0: Always 1: Run command and frequency command by communication are enabled. 2: During run by communication	-	1	Immediately	Enabled	[8. 3]

Communication No.	Title	Parameter name	Adjustment range	Unit	Default setting	Data reflection	MODBUS protocol	Reference
0829	F829	RS485 (2) wiring type	0: 2-wire 1: 4-wire	-	0	Immediately	Enabled	[Chapter 3] Note)
0830	F830	MODBUS continuous address	0: Disabled 1: Enabled	-	0	Immediately	Enabled	[6. 1. 3]
0856	F856	Motor pole number for communication	1: 2 poles, 2 - 8: 4 - 16 poles	-	2	Immediately	Enabled	[9. 1]
0870	F870	Block write data 1	0: Disabled					
0871	F871	Block write data 2	1: FA00 (Communication command 1) 2: FA20 (Communication command 2) 3: FA01 (Frequency command) 4: FA50 (TB output) 5: FA51 (Analog output) 6: FA13 (Speed command by communication)	-	0	After reset	Enabled	
0875	F875	Block read data 1	0: Disabled					
0876	F876	Block read data 2	1: FD01 (Status information)					
0877	F877	Block read data 3	2: FD00 (Output frequency)					
0878	F878	Block read data 4	3: FD03 (Output current)					
0879	F879	Block read data 5	4: FD05 (Output voltage) 5: FC91 (Alarm information) 6: FD22 (PID feedback value) 7: FD06 (Input terminal monitor) 8: FD07 (Output terminal monitor) 9: FE35 (Terminal RR monitor) 10: FE36 (Terminal RX monitor) 11: FE37 (Terminal II monitor) 12: FD04 (Input voltage (DC detection)) 13: FD16 (Speed feedback frequency) 14: FD18 (Torque) 15: FE60 (My function output monitor 1) 16: FE61 (My function output monitor 2) 17: FE62 (My function output monitor 3) 18: FE63 (My function output monitor 4) 19: 0880 (Free memorandum) 20: (Motor speed) 21: FD29 (Input power) 22: FD30 (Output power) 23: FC90 (Trip information)	-	0	After reset	Enabled	[5. 1. 3] [6. 1. 2] [6. 1. 5] [6. 1. 6]
0880	F880	Free memorandum	0-65535	1	0	Immediately	Enabled	[8. 5]
0897	F897	Parameter writing	0: Storage to memory device 1: Storage to memory device except by communication	-	0	After reset	Enabled	[8. 6]
0898	F898	Trip reset	0: Clear trip by request from communication option. Reset by request except from communication option. 1: Reset 2: Clear past trips 3 - 5:	-	0	Immediately	Enabled	-
0899	F899	Communication option Reset operation	0: - 1: Reset option and inverter	-	0	Immediately	Enabled	[8. 7]

Note) The following are parameters that have their values affected by [F809].

Communication No.	Title	Parameter name	Adjustment range	Default setting	[F809] (Operation panel connection destination)		
					0: Disabled	1: Connector 1	2: Connector 2
0800	F800	RS485 (1) baud rate	0: 9600bps 1: 19200bps 2: 38400bps	1	setting	1: 19200bps (fixed)	setting
0801	F801	RS485 (1) parity	0: Disabled 1: Even parity 2: Odd parity	1	setting	1: Even parity (fixed)	setting
0806	F806	RS485 (1) inverter-to-inverter communication	0: Follower (0Hz command when Leader fails) 1: Follower (continue running when Leader fails) 2: Follower (emergency off when Leader fails) 3: Leader (transmit frequency command) 4: Leader (transmit output frequency signal) 5: Leader (transmit torque command) 6: Leader (transmit output torque command)	0	setting	0: Follower (fixed)	setting
0820	F820	RS485 (2) baud rate	0: 9600bps 1: 19200bps 2: 38400bps	1	setting	setting	1: 19200bps (fixed)
0821	F821	RS485 (2) parity	0: Disabled 1: Even parity 2: Odd parity	1	setting	setting	1: EVEN (fixed)
0826	F826	RS485 (2) inverter-to-inverter communication	0: Follower (0Hz command when Leader fails) 1: Follower (continue running when Leader fails) 2: Follower (emergency off when Leader fails) 3: Leader (transmit frequency command) 4: Leader (transmit output frequency signal) 5: Leader (transmit torque command) 6: Leader (transmit output torque command)	0	setting	setting	0: Follower (fixed)
0829	F829	RS485 (2) wiring type	0: 2-wire 1: 4-wire	0	setting	setting	0: 2-wire (fixed)

8.1 Baud rate ([F800] or [F820]), Parity bit ([F801] or [F821])

- Set the same baud rate and parity for all units on the network.
- The parameters are reflected after a reset operation such as power off. Reset the power after setting.

8.2 Inverter number ([F802])

Set an individual number to each inverter.

Do not set a same inverter number for more than one inverter in the same network.

If the inverter number specified using independent communication and the inverter number specified using parameter setting do not match, the received data is discarded.

These parameters are reflected from the communication immediately after setting.

- Data range: 0 to 247 (Default setting: 0)

Although parameters from 0 to 247 are available, the inverter number range will be limited as follows depending on the communication protocol.

- | | |
|---|--|
| ● TOSHIBA inverter protocol ASCII mode | : 0 - 99 |
| ● TOSHIBA inverter protocol binary mode | : 0 - 63 |
| ● MODBUS-RTU protocol | : 0 - 247 (0 stands for broadcast communication) |

8.3 Communication time-out detection function ([F803], [F804], [F808], or [F823], [F824], [F828])

This function detects when valid data has never been received within an arbitrarily specified time range. This function is used for detecting disconnected cables during communication. It trips an inverter (Err5) if it fails to receive any data within a time range specified in advance. Note that if a piece of data has a wrong inverter number, or an error that prevents response data from arriving from the inverter (such as a format error), the inverter regards it as receipt failure.

■ How to set the timer

The default settings of [F803: RS485 (1) time-out time] and [F823: RS485 (2) time-out time] are "0.0: Disabled" (Timer OFF).

● Timer adjustment range

Approx. 0.1 sec (01H) - Approx. 100. 0 sec (03E8H)/timer OFF (0H)

■ How to start the timer

If the timer is set via the operation panel, the first communication after the setting starts the timer. If the timer is set by communication, the first communication after the timer setting starts the timer. If the timer is written to EEPROM, the timer starts from the first data communication after power on. Note that if a piece of data has a wrong inverter number, or an error that indicates prevents response data from arriving from the inverter, the inverter regards that no communication has taken place, and does not start the timer.

■ How to select inverter operation if time-out occurs

The default settings of [F804: RS485 (1) time-out time] and [F824: RS485 (2) time-out time] are "1: Continue running". "4" and "6" are both trigger trips (Err5). The difference is that "4" causes tripping immediately after detection and coasting occurs on the motor, while "6" slows down, stops, and then trips the inverter.

■ How to detect a time-out

The default settings of [F808: RS485 (1) time-out detection] and [F828: RS485 (2) time-out detection] are "1: Run command and frequency command by communication are enabled." If a run command from communication or a frequency command is valid, detection occurs. Parameter "2" performs detection only during in operation in addition to the detection conditions for "1". If compatibility with previous models is required, set to "0".

■ How to stop the timer

Set [F803: RS485 (1) time-out time] and [F823: RS485 (2) time-out time] to "0".

Example) When stopping the RS485 (2) timer via communication (an example that sets the value in EEPROM)

Computer -> Inverter Inverter -> Computer

(W08230) CR (W08230000) CR ... Set the timer to 0 to stop the timer.

■ Timer

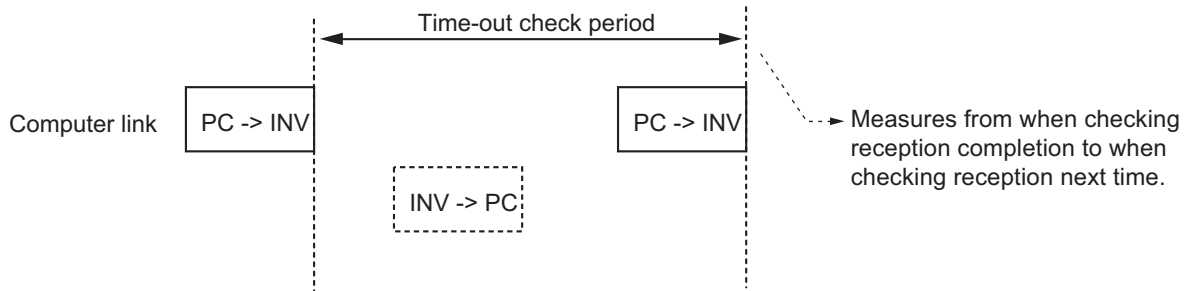

8.4 Transmission wait time ([F805] or [F825])

After the data is received and the transmission wait time elapses, the inverter starts data transmission. Use this function when excessively early responses from the inverters cause difficulty in preparing receipt due to process issues of the computer, or when switching between transmission and receipt takes time inside the converter in case USB/RS485 converter, RS485/RS232C converter, etc. is used.

Function specifications : The inverter waits for the time specified in transmission wait time ([F805] or [F825]) from the end of data receipt to the response with data to the computer or, when in inverter-to-inverter communication, from the last start of transmission to the next start of transmission. However, if the response process capability of the inverter takes more than the specified time, the wait time may exceed the set value. (The parameter is used to prevent wait time from falling below the set value.)

Adjustment range : Function OFF: 0 (0000H), 0.01 sec (0001H) - 2.00 sec (00C8H)
 The function is disabled when the value is set to 0. After the inverter-side process is complete, the inverter immediately starts transmission. If you need quick response, set the value to "0."

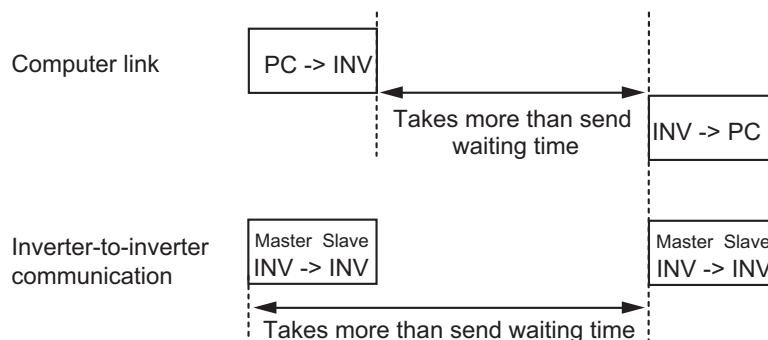

8.5 Free memorandum ([F880])

You can write any data. The parameter does not affect inverter control.
Use it as necessary for storing customer serial number, parameter data, etc.

8.6 Parameter writing ([F897])

When [F897: Parameter writing] is set to "1", all writing via communication is only done to the RAM. This parameter can be used when frequently writing to EEPROM supported parameters, but the content of the parameters return to the values stored in EEPROM each time the inverter is reset.

If you want to temporarily allow storage to EEPROM when [F897] = "1", you can set [FA93] to "1":
Temporarily suppress mode for RAM" to allow writing EEPROM supported parameters.



Important

- The [F897] setting is reflected after a reset operation such as power off, so you need power reset after the setting. In addition, note that if [0897] = "0" is set via communication, the [F897] parameter does not return to "0: Storage to memory device". To set to "0", modify the setting from the operation panel.

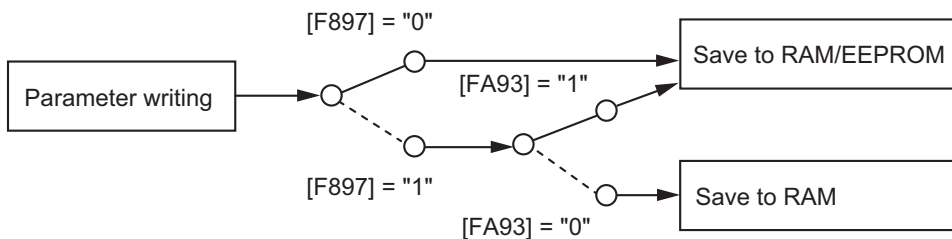

8.7 Communication option reset ([F899])

This parameter can be used to update parameters that need a reset operation after communication-related settings. When [F899] is set to "1", the reset operation is invoked. After reset, the parameter returns to "0".
You cannot use the parameter for clearing the trip status in case of inverter failure.

9 | Control through communication

I

You can use communication to send a command or frequency to the inverter and get status information indicating the inverter status.

1

2

3

4

5

6

7

8

9

10

A1

A2

A3

A4

9.1 Command through communication

■ Communication command 1 "Communication No.: FA00 or FA04"

You can use communication to issue a frequency or run/stop command of the inverter.

VF-AS3 can enable run commands and frequency commands from communication regardless of the settings of [CMOd: Run command select] and [FMOD: Frequency command select 1]. However, when the input terminal functions ([F110] to [F124], [F127], [F128]) are set to either of "48: Communication priority cancel," "56 (57): Forced run," or "58: Fire speed run," the command can be switched to other run commands except for a communication command or a frequency command with ON/OFF of the terminals.

Once the communication command 1 (FA00 or FA04) is set to the run command priority or frequency command priority, the setting remains enabled until it is disabled, the inverter is turned off or reset, or [typ: Default setting] is set.

Even when the emergency off and PID control prohibition are not set to the communication command priority, they are always valid.

Table 1 Communication command 1 (communication No. FA00 or FA04) data configuration

Bit	Function	0	1	Remarks
0	Preset speed switching 1	0000: Preset speed OFF Use 0001 to 1111 to specify preset speed 1 to 15.		Use 4-bit combinations to specify preset speed OFF or preset speed 1 to 15.
1	Preset speed switching 2			
2	Preset speed switching 3			
3	Preset speed switching 4			
4	V/f switching	V/f1	V/f2	V/f1: [Pt] = Setting value, [vL], [vLv], [vb], [tHrA] V/f2: [Pt] = 0, [F170], [F171], [F172], [F182]
5	PID control OFF	OFF	ON	
6	Acc/Dec switching	Acc/Dec 1	Acc/Dec 2	Acc/Dec 1: [ACC], [dEC] Acc/Dec 2: [F500], [F501]
7	DC braking	OFF	Forced DC braking	
8	Jog run	OFF	Jog run	
9	Fwd/Rev	Fwd run	Rev run	
10	Run/Stop	Stop	Run	
11	Coast stop	Ready for run	Coast stop	
12	Emergency off	OFF	Emergency off	Always valid, occurrence of an [E] trip
13	Reset	OFF	Reset	
14	Frequency command priority	OFF	Priority	Valid regardless of the setting of [FM0d]
15	Run command priority	OFF	Priority	Valid regardless of the setting of [CM0d]

Note 1) The Acc/Dec switching command has an "OR" relationship with bit8 of the communication No.: FA20 or FA22.

Note 2) The V/f switching command has an "OR" relationship with bit10 of the communication No.: FA20 or FA22.

Example: Forward operation command (PFA008400) CR

Set 1 to BIT15 (communication command enabled) and BIT10 (run command).

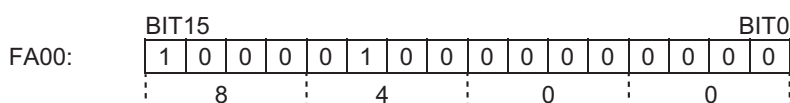

[Example] Reverse operation (PFA008600) CR, (PFA00C600) CR

8600H: When the frequency command is not set to communication

C600H: When the frequency command is set to communication enabled

■ Communication command 2 "Communication No.: FA20 or FA22"

This command is valid only when a run command priority is enabled. Set BIT15 of the communication command 1 (communication No.: FA00 or FA04) to "1: Valid."

With setting of communication command 1, a command through communication can have higher priority, regardless of the setting of [CMOD: Run command select]. However, when the input terminal functions ([F110] to [F124], [F127], [F128]) are set to either of "48: Communication priority cancel," "56: Forced run," or "58: Fire speed run," the command can be switched to other run commands except for a communication command or a frequency command with ON/OFF of the terminals. Once this setting is enabled, it remains valid until it is disabled (set to 0), the inverter is turned off or reset, or [typ: Default setting] is set. Note that the power integral value clear is always valid even when the communication command does not have higher priority.

Table 2 Communication command 2 (FA20 or FA22) data configuration

Bit	Function	0	1	Remarks
0	Speed control/ Torque control switching	Speed control	Torque control	
1	Integral power clear	OFF	Clear	Clear the integral power (FE76, FE77).
2	(Reserved)	-	-	
3	Brake	Normal	Forced close	
4	Preliminary excitation	Normal	Action	
5	(Reserved)	-	-	
6	Brake answerback	Brake close	Brake open	
7	Minimize deceleration forced stop	Normal	Action	
8	Acc/Dec switching 1	00: Acc/Dec 1 01: Acc/Dec 2 10: Acc/Dec 3 11: Acc/Dec 4		Use 2-bit combinations to select Acc/Dec 1 to 4. Acc/Dec 1: [ACC], [dEC] Acc/Dec 2: [F500], [F501] Acc/Dec 3: [F510], [F511] Acc/Dec 4: [F514], [F515]
9	Acc/Dec switching 2			
10	V/f switching 1	00: V/f1 01: V/f2 10: V/f3 11: V/f4		Use 2-bit combinations to select V/f1 to 4 V/f1: [Pt] = Setting value, [vL], [vLv], [vb], [tHrA] V/f2: [Pt] = 0, [F170], [F171], [F172], [F182] V/f3: [Pt] = 0, [F174], [F175], [F176], [F183] V/f4: [Pt] = 0, [F178], [F179], [F180], [F184]
11	V/f switching 2			

Bit	Function	0	1	Remarks
12	Torque limit switching 1 (Stall prevention switching)	00: Torque limit 1 (Stall prevention level 1) 01: Torque limit 2 (Stall prevention level 2)		Stall prevention level 1: [F601] Stall prevention level 2: [F185] Use 2-bit combinations to select Torque limit 1 to 4. Torque limit 1: [F441], [F443] Torque limit 2: [F444], [F445] Torque limit 3: [F446], [F447] Torque limit 4: [F448], [F449]
13	Torque limit switching 2	10: Torque limit 3 (Stall prevention level 1) 11: Torque limit 4 (Stall prevention level 2)		
14	Speed control gain switching	Gain 1	Gain 2	Gain 1: [F460], [F461], [F462] Gain 2: [F463], [F464], [F465]
15	(Reserved)	-	-	

- Note 1) Set "0" to the reversed bit. Setting "1" may cause a command to be accepted correctly.
- Note 2) The Acc/Dec switching command 1 has an "OR" relationship with bit6 of the communication No.: FA00 or FA04. To switch the four types of Acc/Dec, set bit6 of FA00 or FA04 to "0," and use FA20 or FA22.
- Note 3) The V/f switching command 1 has an "OR" relationship with bit4 of the communication No.: FA00 or FA04. To switch the four types of Acc/Dec, set bit4 of FA00 or FA04 to 0, and use FA20 or FA22.

■ Communication command 3 "Communication No.: FA26 or FA28"

The terminal [R1] output hold command and terminal [FP] output hold command are always valid even when the communication command does not have higher priority.

Table 3 Communication command 3 (FA26 or FA28) data configuration

Bit	Function	0	1	Remarks
0	Terminal R1 output hold	OFF	The terminal [R1] remains ON once it is turned on.	It is always valid even when the communication command is not enabled.
1	Terminal FP output hold	OFF	The terminal [FP] remains ON once it is turned on.	It is always valid even when the communication command is not enabled.
2	(Reserved)	-	-	
3	(Reserved)	-	-	
4	(Reserved)	-	-	
5	(Reserved)	-	-	
6	(Reserved)	-	-	
7	(Reserved)	-	-	
8	(Reserved)	-	-	
9	(Reserved)	-	-	
10	(Reserved)	-	-	
11	(Reserved)	-	-	
12	(Reserved)	-	-	
13	(Reserved)	-	-	
14	(Reserved)	-	-	
15	(Reserved)	-	-	

Note 1) Set "0" to the reversed bit. Setting "1" may cause a command to be accepted correctly.

- Frequency command through communication "Communication No.: FA01 or FA05"

Adjustment range: 0 to [FH: Maximum frequency]

This frequency command is valid only when a frequency command through communication is enabled. To enable a frequency command through communication, set RS485 communication in [FM0d: Frequency command select 1] (set the communication No. 0004 to "21: RS485 (communication connector 1)" or "22: RS485 (communication connector 2)"), or set the frequency priority in the communication command 1 (set bit 14 of the communication No.: FA00 or FA04 to 1 (valid)). In this case, the frequency command through communication is valid regardless of the setting of [FM0d].

However, when the input terminal functions ([F110] to [F124], [F127], [F128]) are set to either of "48: Communication priority cancel," "56 (57): Forced run," or "58: Fire speed run" and the function is enabled, the valid command or frequency has higher priority.

Once this frequency setting is enabled, it remains valid until it is disabled (set to 0), the inverter is turned off or reset, or [typ: Default setting] is set.

To set a frequency through communication,

specify a hexadecimal number (1 = 0.01 Hz (unit)) to the communication No.: FA01 or FA05.

Example: Operation frequency 80 Hz command (PFA011F40) CR

$$80 \text{ Hz} = 80/0.01 = 8000 = 1F40H$$

- Motor speed command value through communication "Communication No.: FA13 or FA19"

Adjustment range: 0 to 32700 min⁻¹

You can set [F856: Motor pole number for communication] to input the motor speed command from FA13 or FA19.

Use the following expression to convert from motor speed to a frequency command. If the converted value of the frequency command exceeds the value of [FH: Maximum frequency], no data can be written to FA13 or FA19, and an error is returned to higher-order communication numbers.

$$\text{Output frequency [0.01 Hz]} = (\text{Motor speed command value [FA13]} \times \text{Motor pole number [F856]})/120$$

This frequency command is valid only when a frequency command through communication is enabled. To enable a frequency command through communication, set RS485 communication in [FM0d: Frequency command select 1] ("21: RS485 (communication connector 1)" or "22: RS485 (communication connector 2)"), or set the frequency priority in the communication command 1 (set bit 14 of the communication No.: FA00 or FA04 to 1 (valid)). In this case, the frequency command through communication is valid regardless of the setting of [FM0d].

However, when the input terminal functions ([F110] to [F124], [F127], [F128]) are set to either of "48: Communication priority cancel," "56: Forced run," or "58: Fire speed run" and the function is enabled, the valid command or frequency has higher priority.

Once this frequency setting is enabled, it remains valid until it is disabled (set to 0), the inverter is turned off or reset, or [typ: Default setting] is set.

To set a motor speed command through communication,

specify a hexadecimal number (1 = min⁻¹ (unit)) to the communication No.: FA13 or FA19.

[Example] For a speed of 1800 min⁻¹ with [F856] set to "2: 4 pole"

$$60.00 \text{ Hz} = (1800 \text{ min}^{-1} \times 4 \text{ poles})/120$$

■ Torque command through communication "FA30 or FA32"

Set a torque command value to the inverter.

This torque command value is valid only when a torque command through communication is enabled where the inverter control selection is torque control (when [Pt] is set to "9" or "11," torque control is selected on the input terminal or by a communication command).

To enable a torque command through communication, set the [F420: Torque command select] (communication No. 0420) to "21: RS485 communication (connector 1)" or "22: RS485 communication (connector 2)." Once the torque command value through communication is enabled, it remains valid until it is set again, the inverter is turned off or reset, or [tyP: Default setting] is set. (FA30 and FA32 do not support EEPROM. Data is cleared after the inverter is turned off or reset).

To set the torque command value through communication, specify a hexadecimal number (1 = 0.01% (unit)) to the torque command value (RS485 communication 1: FA30, RS485 communication 2:FA32).

Example: Torque command 50 % (PFA321388)

$$50 \% = 50/0.01 = 5000 = 1388H$$

■ Terminal output data "FA50"

Through communication, you can directly control the output terminal of the inverter.

Before using this function, select the function number ("92" to "95") in the output terminals ([F130], [F132]). By setting data of bit 0 to 1 of terminal output data (FA50) through communication, you can output setting data (0 or 1) from the output terminal.

Terminal output data (FA50) data configuration

Bit	Output terminal function	0	1
0	"92/93: Designated data bit 0"	OFF	ON
1	"94/95: Designated data bit 1"	OFF	ON
2 to 15	(Reserved)	-	-

Note 1) Set "0" to the reversed bit. Setting "1" may cause a command to be accepted correctly.

Usage example: When you want to control only the terminal FP through communication

Set [F130: Terminal FP function 1] to "92: Specified data output 0" beforehand.

Set 0001H to FA50, and the terminal [FP] is turned on.

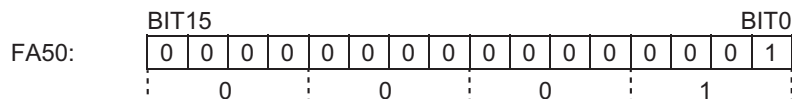

■ FM terminal output data "FA51"

Through communication, you can directly control the terminal [FM] of the inverter.

Before using this function, set [FMSL: Terminal FM function] to "31: Communication data output."

From the selected terminal [FM], the data specified for [F51: Terminal FM output data] can be output.

The adjustment range of data is 0 to 100.0 %.

For details, refer to "Adjusting the meter connected to the inverter" of the inverter instruction manual (E6582062).

■ Terminal AM output data "FA52"

Through communication, you can directly control the terminal [AM] of the inverter.

Before using this function, set [F670: Terminal AM function] to "31: Communication data output."

From the terminal [AM], the data specified for [F52: Terminal AM output data] can be output.

The adjustment range of data is 0 to 100.0 %.

For details, refer to "Adjusting the meter connected to the inverter" of the inverter instruction manual (E6582062).

■ Reset check data "FA87"

When you set 1 to communication and periodically read data, you can judge whether the inverter has been reset.

After the inverter is reset, data is automatically returned to 0.

9.2 Monitor through communication

This section describes the status monitor of the inverter.

- Output frequency monitor in communication (FD00, FE00)**
 Output frequency (current status): "Communication No. FD00" (Unit: 0.01 Hz)
 Output frequency (retain data immediately before the trip): "Communication No. FE00" (Unit: 0.01 Hz)

Example: Operation frequency monitor (while the inverter is running at 50 Hz) ... (1388H = 5000 d, $5000 \times 0.01 = 50$ Hz)

Computer -> Inverter Inverter -> Computer
 (RFD00)_{CR} (RFD001388)_{CR}

- Status information 1 (FD01, FE01)**
 Status information 1 (current status): "Communication No. FD01"
 Status information 1 (retain data immediately before the trip): "Communication No. FE01"

Bit	Function	0	1	Remarks
0	Failure FL	No output	Being output	
1	Failure	No trip	During trip	When the inverter is in a retry process or retains trip records, these states also indicate the inverter tripped.
2	Alarm	No alarm	Alarm occurring	
3	Undervoltage (main circuit) (MOFF)	Normal	Undervoltage	
4	V/f status	V/f1	V/f2	V/f1: [Pt] = Setting value, [vL], [vLv], [vb], [tHrA] V/f2: [Pt] = 0, [F170], [F171], [F172], [F182]
5	PID control OFF	OFF	ON	
6	Acc/Dec 1 and 2 selection	Acc/Dec 1	Acc/Dec 2	Acc/Dec 1: [ACC], [dEC] Acc/Dec 2: [F500], [F501]
7	DC braking	OFF	During DC braking	
8	Jog run	OFF	During jog run	
9	Fwd/Rev	Fwd run	Rev run	
10	Run/Stop	Stop	Run	
11	Coast stop (Standby (ST) OFF)	ST = ON	ST = OFF	This bit is also set for open terminals of [STOA] - [STOB] - [PLC].

Bit	Function	0	1	Remarks
12	In emergency off	No emergency off	In emergency off	
13	Ready for run 1 (Standby (ST) ON)	Getting ready for run	Ready for run	Ready for run: Initialization completed, no abnormal stop, no alarm stop (MOFF, COFF, STOP, LStP), ST = ON (short-circuit between the terminals [STOA] - [STOB] - [PLC], Run command = ON
14	Ready for run 2	Getting ready for run	Ready for run	Ready for run: Initialization completed, no abnormal stop, no alarm stop (MOFF, LL stop)
15	HAND/AUTO (LOC/REM)	AUTO (REM)	HAND (LOC)	This is valid when [F750] is set to "2." HAND: Operations from the operation panel are valid. AUTO: Operations according to the run command selection or frequency command selection are valid. This is valid when [F732] is set to "0." LOC: Operations from the operation panel are valid. REM: Operations according to the run command selection or frequency command selection are valid.

Note 1) Do not include an undefined bit into a conditional judgment.

9

■ Output current monitor in communication (FD03, FE03)

Output current (current status): "Communication No. FD03" (Unit: 0.01 %)

Output current (retain data immediately before the trip): "Communication No. FE03" (Unit: 0.01 %)

Present output current is read as a hexadecimal number in the unit 0.01 %.

For example, when the inverter with a rated current of 4.8 A outputs a current of 50 % (2.4 A), 1388H (hexadecimal number) is read. The unit is 0.01 %.

$0 \times 1388H$ (hexadecimal number) = 5000 (decimal number) $\times 0.01 = 50$ (%)

[Example] Output current monitor (an output current of 90 %) ... (2328H = 9000 d, $9000 \times 0.01 = 90$ %)

Computer -> Inverter Inverter -> Computer
 (RFD03)_{CR} (RFD032328)_{CR}

Calculate the following items in the same way:

- FD05 (output voltage) Unit: 0.01 % (V)
- FD04 (voltage in the DC section) Unit: 0.01 % (V)

■ Input terminal monitor (FD06, FE06)

Input terminal monitor (current status): "Communication No. FD06"

Input terminal monitor (retain data immediately before the trip): "Communication No. FE06"

For input terminals, you can assign functions with parameters.

When you set "0: No function", you can use an input terminal for you because turning on or off the terminal does not affect inverter operations.

For monitoring, make sure what function is set for each input terminal function selection.

Input terminal monitor (FD06, FE06) data configuration

Bit	Terminal name	Function [parameter name]	0	1		
0	F	Terminal F function 1 [F111]	OFF	ON		
1	R	Terminal R function 1 [F112]				
2	RES	Terminal RES function 1 [F113]				
3	S1	Terminal S1 function 1 [F114]				
4	S2	Terminal S2 function [F115]				
5	S3	Terminal S3 function [F116]				
6	S4	Terminal S4 function [F117]				
7	S5	Terminal S5 function [F118]				
8	DI11	Terminal DI11 function [F119]				
9	DI12	Terminal DI12 function [F120]				
10	DI13	Terminal DI13 function [F121]				
11	DI14	Terminal DI14 function [F122]				
12	DI15	Terminal DI15 function [F123]				
13	DI16	Terminal DI16 function [F124]				
14	(Undefined)	-			-	-
15	(Undefined)	-			-	-

Note 1) Do not include an undefined bit into a conditional judgment.

Example: When both terminals [F] and [S2] are ON, FE06 data = 0011H

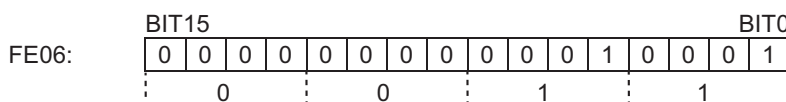

■ Analog input monitor (FE35 to FE39)

Terminal RR input value (current status): "Communication No. FE35" (Unit: 0.01 %)

Terminal RX input value (current status): "Communication No. FE36" (Unit: 0.01 %)

Terminal II input value (current status): "Communication No. FE37" (Unit: 0.01 %)

Terminal AI4 input value (current status): "Communication No. FE38" (Unit: 0.01 %)

Terminal AI5 input value (current status): "Communication No. FE39" (Unit: 0.01 %)

This monitor allows you to use the inverter also as an A/D converter regardless of inverter control. The terminal RR input value, terminal II input value, and terminal AI5 input value can be read with an external input value set to 0.00 to 100.00 % (long word without sign = 0H to 2710H).

The terminal RX input value and terminal AI4 input value can be read with an external input value set to -100.00 to 100.00 % (signed signal = D8F0H to 2710H).

However, note that when the analog input is set in the frequency command selection, input data to analog is regarded as a frequency command.

■ Status information 2 (FD42, FE42)

Status information 2 (current status): "Communication No. FD42"

Status information 2 (retain data immediately before the trip): "Communication No. FE42"

Bit	Function	0	1	Remarks
0	Speed control/Torque control switching status	Speed control	Torque control	
1	Integral power clear	Counting	Clearing	
2	(Undefined)	-	-	
3	(Undefined)	-	-	
4	Preliminary excitation	Normal	During operation	
5	(Undefined)	-	-	
6	(Undefined)	-	-	
7	Minimize deceleration forced stop	Normal	During operation	
8	Acc/Dec switching 1	00: Acc/Dec 1, 01: Acc/Dec 2 10: Acc/Dec 3, 11: Acc/Dec 4		Use 2-bit combinations to select Acc/Dec 1 to 4.
9	Acc/Dec switching 2			
10	V/f switching 1	00: V/f1, 01: V/f2 10: V/f3, 11: V/f4		Use 2-bit combinations to select V/f1 to 4.
11	V/f switching 2			
12	Torque limit switching 1	00: Torque limit 1 (Stall 1) 01: Torque limit 2 (Stall 2) 10: Torque limit 3 11: Torque limit 4		Use 2-bit combinations to select Torque limit 1 to 4.
13	Torque limit switching 2			
14	Speed control gain switching			

Bit	Function	0	1	Remarks
15	(Undefined)	-	-	

Note 1) Do not include an undefined bit into a conditional judgment.

■ Status information 3 (FD49, FE49)

Status information 3 (current status): "Communication No. FD49"

Status information 3 (retain data immediately before the trip): "Communication No. FE49"

Bit	Function	0	1	Remarks
0	Terminal R1 output hold	OFF	ON	
1	Terminal FP output hold	OFF	ON	
2	(Undefined)	-	-	
3	(Undefined)	-	-	
4	(Undefined)	-	-	
5	(Undefined)	-	-	
6	(Undefined)	-	-	
7	(Undefined)	-	-	
8	(Undefined)	-	-	
9	(Undefined)	-	-	
10	Running status (during constant speed run)	OFF	ON	
11	Inverter healthy signal	OFF	ON	The signal is repeatedly turned ON or OFF every one second.
12	Acceleration/deceleration completion (RCH)	OFF	ON	[F102]
13	Specified frequency attainment (RCHF)	OFF	ON	[F101], [F102]
14	Running status (during acceleration)	OFF	ON	
15	Running status (during deceleration)	OFF	ON	

Note 1) Do not include an undefined bit into a conditional judgment.

■ Run command select (FD45)

Run command selection status (current status): "Communication No. FD45"

Monitor the currently valid run command source.

Data	Valid run command
0	Terminal
1	Operation panel, Extension panel
2	Embedded Ethernet
3	RS485 (connector 1)
4	RS485 (connector 2)
5	Communication option

Note 1) This data changes depending on model. No compatibility among models is provided.

■ Frequency command select (FD46)

Frequency command selection status (current status): "Communication No. FD46"

Monitor the currently valid frequency command source.

Data	Valid frequency command
0	-
1	Terminal RR
2	Terminal RX
3	Terminal II
4	Terminal AI4 (option)
5	Terminal AI5 (option)
6	-
7	-
8	-
9	-
10	Touch wheel 1 (power off or press OK to save)
11	Touch wheel 2 (press OK to save)
12	Preset speed frequency (Sr0)
13	-
14	-
15	Terminal Up/Down frequency
16	Pulse train

Data	Valid frequency command
17	High resolution pulse train (option)
18	-
19	-
20	Embedded Ethernet
21	RS485 (connector 1)
22	RS485 (connector 2)
23	Communication option
24 to 254	-
255	Preset speed frequency (except for sr0)

Note 1) This data changes depending on model. No compatibility among models is provided.

■ Motor speed (FD90, FE90)

Motor speed (current status): "Communication No. FD90" (Unit: 1 min^{-1})

Motor speed (retain data immediately before the trip): "Communication No. FE90" (Unit: 1 min^{-1})

Example: Motor speed monitor (while the motor with 4 poles is running at 60 Hz) ... (0708H = 1800 d, 1800 min^{-1})

Use [F856] to specify the number of motor poles. Use the following expression to convert from the actual output frequency to motor speed:

Motor speed [min^{-1}] = (120 x Output frequency [0.01 Hz])/Number of motor poles [F856]

$$1800 \text{ min}^{-1} = (120 \times 60.00 \text{ Hz}) / 4$$

Computer -> Inverter Inverter -> Computer
 (RFE90)_{CR} (RFE900708)_{CR}

■ Alarm information (FC91)

Bit	Specifications	0	1	Remarks (panel display, etc.)
0	Overcurrent pre-alarm	Normal	Alarm occurring	[C] flashes.
1	Inverter overload pre-alarm	Normal	Alarm occurring	[L] flashes.
2	Motor overload pre-alarm	Normal	Alarm occurring	[L] flashes.
3	Overheat pre-alarm	Normal	Alarm occurring	[H] flashes.
4	Overvoltage pre-alarm	Normal	Alarm occurring	[P] flashes.
5	(Undefined)	-	-	-
6	Internal overheat pre-alarm	Normal	Alarm occurring	[L] flashes.
7	Low-current alarm	Normal	Alarm occurring	-
8	Over-torque alarm	Normal	Alarm occurring	-
9	Braking resistor overload alarm	Normal	Alarm occurring	-
10	Cumulative run time alarm	Normal	Alarm occurring	-
11	Communication option alarm	Normal	Alarm occurring	[t] flashes.
12	RS485 communication alarm	Normal	Alarm occurring	[t] flashes.
13	When power circuit undervoltage alarm	Normal	Alarm occurring	[MOFF] flashes.
14	During deceleration stop at power failure	-	During deceleration stop	[StOP] flashes.
15	During run sleep	-	During deceleration stop	[LStP] flashes.

Note 1) Do not include an undefined bit into a conditional judgment.

■ Parts replacement alarm monitor (FE79)

Bit	Specifications	0	1	Remarks
0	Cooling fan replacement alarm	Normal	Alarm occurring	-
1	Board capacitor replacement alarm	Normal	Alarm occurring	-
2	Main circuit capacitor replacement alarm	Normal	Alarm occurring	-
3	Cumulative run time alarm	Normal	Alarm occurring	Related parameter: [F621]
4	Number of starting alarm	Normal	Alarm occurring	Related parameter: [F648]
5	Number of external equipment starting alarm	Normal	Alarm occurring	Related parameter: [F658]

Bit	Specifications	0	1	Remarks
4 to 15	(Undefined)	-	-	-

Note 1) Do not include an undefined bit into a conditional judgment.

■ Trip monitor

(Current status: FC90, Past history: FE10 to FE13, FD10 to FD13)

Display	Data (Hexadecimal)	Data (Decimal)	Description
nErr	0	0	No trip
OC1	1	1	Overcurrent (during acceleration)
OC2	2	2	Overcurrent (during deceleration)
OC3	3	3	Overcurrent (during constant speed running)
OCL	4	4	Overcurrent (load side at startup)
OCA1	5	5	Overcurrent (U-phase arm)
OCA2	6	6	Overcurrent (V-phase arm)
OCA3	7	7	Overcurrent (W-phase arm)
EPHI	8	8	Input phase loss
EPHO	9	9	Output phase loss
OP1	A	10	Overvoltage (during acceleration)
OP2	B	11	Overvoltage (during deceleration)
OP3	C	12	Overvoltage (during constant speed running)
OL1	D	13	Overload (Inverter)
OL2	E	14	Overload (Motor)
OLr	F	15	Overload (Braking resistor)
OH	10	16	Overheat
E	11	17	Emergency off
EEP1	12	18	EEPROM fault 1 (writing error)
EEP2	13	19	EEPROM fault 2 (reading error)
EEP3	14	20	EEPROM fault 3 (internal failure)
Err2	15	21	RAM fault
Err3	16	22	ROM fault
Err4	17	23	CPU 1 fault A
Err5	18	24	Communication time-out (RS485)

Display	Data (Hexadecimal)	Data (Decimal)	Description
Err6	19	25	Gate array fault
Err7	1A	26	Current detector fault
Err8	1B	27	Communication time-out (option)
Err9	1C	28	Panel disconnection during run
UC	1D	29	Undercurrent
UP1	1E	30	Undervoltage (main circuit)
Ot	20	32	Overtorque
EF2	22	34	Grounding fault
OCr	24	36	Overcurrent (Braking resistor)
Etn	28	40	Auto-tuning error
EtyP	29	41	Inverter type error
E-11	2B	43	Brake answer error
E-12	2C	44	PG error
E-13	2D	45	Abnormal speed error
OH2	2E	46	External thermal trip
SOUT	2F	47	PM step-out
E-18	32	50	Analog input disconnecting
E-19	33	51	CPU communication error
E-20	34	52	Over torque boost
E-21	35	53	CPU 1 fault B
E-22	36	54	Embedded Ethernet fault
E-23	37	55	Option fault (slot 1)
E-24	38	56	Option fault (slot 2)
E-25	39	57	Option fault (slot 3)
E-26	3A	58	CPU2 fault
PrF	3B	59	STO circuit fault
Ut	3C	60	Undertorque
E-29	3D	61	Control power option failure
OL3	3E	62	Overload (IGBT)
E-31	3F	63	Rush current suppression relay fault
E-32	40	64	PTC failure

Display	Data (Hexadecimal)	Data (Decimal)	Description
Ot2	41	65	Overtorque 2
E-37	45	69	Servo lock error
E-39	47	71	PM control error
OtC3	48	72	Overtorque/Overcurrent
UtC3	49	73	Undertorque/Undercurrent
E-42	4A	74	Cooling fan fault
E-43	4B	75	Communication time-out (embedded Ethernet)
E-44	4C	76	Battery of panel failure
E-45	4D	77	GD2 tuning error
Etn1	54	84	Auto-tuning error 1
Etn2	55	85	Auto-tuning error 2
Etn3	56	86	Auto-tuning error 3
E-99	47	71	Trip for test

9.3 Using the panel (LED, keys) through communication

Communication from an external controller allows you to see necessary data on the extension panel of the inverter or to input data with keystrokes. You can use the extension panel of the inverter to reduce the cost of the entire system.

9.3.1 LED settings through communication

When using the options of the extension panel (RKP002Z, RKP007Z), you can see any LED information through communication.

■ How to set the parameter

Set [F720: Standard mode display of extension panel] to "30: Communication LED setting."

In the monitor mode, the LED appears according to the setting of the communication No. FA65. (In the default settings, the communication No. FA65 is set to "1," and the initial data of FA70 to FA74 is "data".)

If an alarm occurs while you are setting the communication LED, the specified LED data and the alarm appear alternately.

For example, if an overcurrent pre-alarm (display [C]) occurs while "60.0" is displayed in this function, you see the following:

"C ↔" 60.0"

Communication No.	Parameter name	Adjustment range	Default setting
FA65	LED display by communication	0: Numerical data (FA66, FA67, FA68) 1: ASCII data 1 (FA70, FA71, FA72, FA73, FA74) 2: ASCII data 2 (FA75, FA76, FA77, FA78, FA79)	1
FA66	FA65=0 numerical value	0 to 9999	0
FA67	FA65=0 decimal point	0: No decimal point (xxxx) 1: First decimal place (xxx.x) 2: Second decimal place (xx.x)	0
FA68	FA65=0 unit	0: Hz off, % off, 1: Hz on, % off 2: Hz off, % on, 3: Hz on, % on	0
FA70	FA65=1 1st digit from left	0 to 127 [0 to 7FH] (Refer to the ASCII LED display code table)	100 [64H] ('d')
FA71	FA65=1 2nd digit from left	0 to 256 [0 to FFH] (Refer to the ASCII LED display code table)	65 [41H] ('a')
FA72	FA65=1 3rd digit from left	0 to 256 [0 to FFH] (Refer to the ASCII LED display code table)	116 [74H] ('t')
FA73	FA65=1 4th digit from left	0 to 127 [0 to 7FH] (Refer to the ASCII LED display code table)	65 [41H] ('a')

Communication No.	Parameter name	Adjustment range	Default setting
FA74	FA65=1 unit	0: Hz off, % off, 1: Hz on, % off 2: Hz off, % on, 3: Hz on, % on	0
FA75	FA65=2 1st digit from left	0 to 127 [0 to 7FH] (Refer to the ASCII LED display code table)	48 [30H] (‘0’)
FA76	FA65=2 2nd digit from left	0 to 256 [0 to FFH] (Refer to the ASCII LED display code table)	48 [30H] (‘0’)
FA77	FA65=2 3rd digit from left	0 to 256 [0 to FFH] (Refer to the ASCII LED display code table)	48 [30H] (‘0’)
FA78	FA65=2 4th digit from left	0 to 127 [0 to 7FH] (Refer to the ASCII LED display code table)	48 [30H] (‘0’)
FA79	FA65=2 unit	0: Hz off, % off, 1: Hz on, % off 2: Hz off, % on, 3: Hz on, % on	0

■ LED display block communication function

For ASCII display LED data, there are two methods to display synchronized data in each digit.

- Set data of each digit and then enable the set data in [FA65: LED display by communication].
- Synchronize data by writing to the LED data parameter at a time by block communication.

Data is written to RAM for block communication because the limit of the number of writing times to EEPROM is considered. In this case, the data is returned to the initial value "dAtA" after the inverter is turned off, reset, or restored to the default setting.

Block communication

● Parameter setting

[FA80: LED display/Block communication switching]

0: Using the block communication parameters ([F870] to [F879]) (default setting)

1: Using LED display ASCII data (ASCII display data 1 communication No. [FA70] to [FA74]) for writing and LED display data before changed for reading)

* This function works only when the Toshiba protocol ([F807], [F827] = 0) is selected.

* To enable the LED data, you should set [F720: Standard mode display of extension panel] to "30: Communication LED setting" and set [FA65: LED display by communication] to ASCII data 1.

● Format

The format is the same as that used in the typical block communication (refer to [4.1.3 Block communication transmission format]), however, the following are different.

- The block communication parameters ([F870] to [F879]) are invalid.
- Written data is fixed to ASCII display data 1 (communication No. [FA70] to [FA74]), and actual data displayed in the LED is for reading.
- Specify the number of writing times in the range of 0 to 5.

Examples:

[F720: Standard mode display of extension panel] = "30"

[FA65: LED display by communication] = "1" (ASCII data 1)

[FA80: LED display/Block communication switching] = "1" LED display ASCII data

When the default setting "dAtA" is displayed in the LED

PC -> INV: 2F580505003000310032003300035A ... "0123" display command

INV -> PC: 2F59050000640041007400410000E7 ... Display data before changed is "dAtA"

• ASCII LED display data code table (BLANK for 00H to 1FH)

Hex Code	LED display	Char.	Hex Code	LED display	Char.	Hex Code	LED display	Char.	Hex Code	LED display	Char.
00H	BLANK		20H	BLANK	SP	40H	BLANK	@	60H	BLANK	`
01H	BLANK		21H	BLANK	!	41H		A	61H		a
02H	BLANK		22H	BLANK		42H		B	62H		b
03H	BLANK		23H	BLANK	#	43H		C	63H		c
04H	BLANK		24H	BLANK	\$	44H		D	64H		d
05H	BLANK		25H	BLANK	%	45H		E	65H		e
06H	BLANK		26H	BLANK	&	46H		F	66H		f
07H	BLANK		27H	BLANK		47H		G	67H		g
08H	BLANK		28H		(48H		H	68H		h
09H	BLANK		29H)	49H		I	69H		i
0AH	BLANK		2AH	BLANK	*	4AH		J	6AH		j
0BH	BLANK		2BH	BLANK	+	4BH		K	6BH		k
0CH	BLANK		2CH	DGP	,	4CH		L	6CH		l
0DH	BLANK		2DH		-	4DH		M	6DH		m
0EH	BLANK		2EH	DGP	.	4EH		N	6EH		n
0FH	BLANK		2FH		/	4FH		O	6FH		o
10H			30H		0	50H		P	70H		p
11H			31HT		1	51H		Q	71H		q
12H			32H		2	52H		R	72H		r
13H			33H		3	53H		S	73H		s
14H			34H		4	54H		T	74H		t
15H			35H		5	55H		U	75H		u
16H			36H		6	56H		V	76H		v
17H			37H		7	57H	BLANK	W	77H	BLANK	w
18H			38H		8	58H	BLANK	X	78H	BLANK	x
19H			39H		9	59H		Y	79H		y
1AH			3AH	BLANK	:	5AH	BLANK	Z	7AH	BLANK	z
1BH			3BH	BLANK	;	5BH		[7BH		{
1CH			3CH		<	5CH		\	7CH	BLANK	
1DH			3DH		=	5DH]	7DH		}
1EH	BLANK		3EH		>	5EH		^	7EH	BLANK	->
1FH	BLANK		3FH	BLANK	?	5FH		_	7FH	BLANK	

* You can add a dot used as a decimal point etc. by setting bit7 (uppermost bit) (80H).
 Example: To set "0." for displaying 60.0, use 30H + 80H = B0H.

10 | Parameter data

This chapter describes data of parameters, etc.

To establish communication, check the communication numbers and adjustment ranges described in the "Table of parameters" of the inverter instruction manual (E6582062).

■ How to see the parameter list

Example of the inverter instruction manual (E6582062)

Title	Communication No.	Parameter name	Adjustment range	Unit	Minimum setting unit (Panel/Communication)	Default setting	User setting	Reference
AUH	-	History function	-	-	-	0		
AUF	-	Guidance function	0 - 6	-	-	0		
AUA	0090	Application easy setting	0 - 7	-	-	0		
AUE	0032	Eco-standby power setting	0 - 1	-	-	0		
AUL	0094	Multi-rating select	0 - 8	-	-	0		
AU1	0000	Automatic Acc/Dec	0: Disabled 1: Automatic 2: Automatic Acc only	-	-	0		
				:	:			
ACC	0009	Acceleration time 1	0, 0 to 6000	s	0.1/0.1	10.0		
dEC	0010	Deceleration time 1	0, 0 to 6000	s	0.1/0.1	10.0		

Below is the communication-related descriptions in the parameter list.

- "Title" indicates the operation panel display of the inverter.
- "Communication No." indicates the communication number (hexadecimal) assigned to each parameter. You need this number to specify a parameter for communication.
- "Adjustment range" indicates the data setting range of that parameter. Data out of the range cannot be set. Data is expressed as a decimal number. To set data from communication, consider the minimum setting unit and write it as a hexadecimal number.
- "Minimum setting unit" indicates a unit represented by data = 1. (The minimum setting unit "-" represents 1 = 1). For example, the minimum setting unit of [ACC: Acceleration time 1] is 0.1, which represents 1 = 0.1 s. Therefore, to set 10 seconds in communication, send 10/0.1 = 100

= 64 h. For the communication number 0999 = 2, the minimum setting units of acceleration/ deceleration time parameters ([ACC], [dEC], [F500], [F501], [F510], [F511], [F514], [F515]) are 0.1 second. For the communication number 0999 = 1, the minimum setting unit is 0.01 second.

Acc/Dec time unit record (0999)

Communication No.	Function	Unit	Adjustment range
0999	Acc/Dec time unit record	-	1: 0.01 second (0.01 to 360.00) 2: 0.1 second (0.1 to 3600.0)

Note) For the communication number 0999, data is read only. Do not write it. To switch the Acc/Dec time unit, use [F519: Unit of Acc/Dec time].

- 5 Negative data is handled as a two's-complement number (Example. FFFFH represents -1).
- 6 When the block read command (03H) for Modbus communication is used, a reading address varies depending on the setting of [F830: MODBUS continuous address]. Detail -> Refer to [6. 1. 3 Block reading command: Direct reading (03H)]

■ Command parameter

Parameters that have only RAM data without EEPROM data are returned to their default settings after the inverter is turned off or reset or is restored to default settings. Note that even when you use the W command (for writing to EEPROM and RAM) for a parameter that does not have EEPROM data, data is written to only RAM.

List of command parameters

<Note> The data in the list is expressed as a decimal number.

Communication No.	Parameter name	Adjustment range	Minimum setting unit	Default setting	Write during running	EEPROM
FA00	RS485 (1) Command 1 ^{*1}	0 to 65535	-	0	Yes	Disabled
FA01	RS485 (1) Frequency command value ^{*1}	0 to Maximum frequency (FH)	0.01Hz	0	Yes	Disabled
FA03	Panel operation frequency command value	Lower limit frequency (LL) to upper limit frequency (UL)	0.01Hz	0	Yes	Enabled
FA04	RS485 (2) Command 1 ^{*1}	0 to 65535	-	0	Yes	Disabled
FA05	RS485 (2) Frequency command value ^{*1}	0 to Maximum frequency (FH)	0.01Hz	0	Yes	Disabled
FA08	Hand/Auto selection	0: AUTO 1: HAND	-	0	Yes	Enabled
FA10	Panel key operation by communication ^{*3}	0: Unit, 1: Communication	-	0	Yes	Disabled
FA11	Extension panel Key data ^{*3}	0 to 65535	-	0	Yes	Disabled
FA13	RS485 (1) motor speed command value ^{*1}	0 to 32700 min ⁻¹	1min ⁻¹	0	Yes	Disabled

Communication No.	Parameter name	Adjustment range	Minimum setting unit	Default setting	Write during running	EEPROM
FA19	RS485 (2) motor speed command value ^{*1}	0 to 32700 min ⁻¹	1min ⁻¹	0	Yes	Disabled
FA20	RS485 (1) Command 2 ^{*1}	0 to 65535	-	0	Yes	Disabled
FA22	RS485 (2) Command 2 ^{*1}	0 to 65535	-	0	Yes	Disabled
FA26	RS485 (1) Command 3 ^{*1}	0 to 65535	-	0	Yes	Disabled
FA28	RS485 (2) Command 3 ^{*1}	0 to 65535	-	0	Yes	Disabled
FA30	RS485 (1) Torque command	-250.00 to 250.00	0.01%	0	Yes	Disabled
FA32	RS485 (2) Torque command	-250.00 to 250.00	0.01%	0	Yes	Disabled
FA50	Terminal output data ^{*2}	0 to 65535	1	0	Yes	Disabled
FA51	Terminal FM output data ^{*2}	0 to 100.0	0.1%	0	Yes	Disabled
FA52	Terminal AM output data ^{*2}	0 to 100.0	0.1%	0	Yes	Disabled
FA65	LED display by communication ^{*3}	0 to 2	-	1	Yes	Enabled
FA66	FA65=0 numerical value ^{*3}	0 to 9999	1	0	Yes	Enabled
FA67	FA65=0 decimal point ^{*3}	0 to 2	-	0	Yes	Enabled
FA68	FA65=0 unit ^{*3}	0 to 3	-	0	Yes	Enabled
FA70	FA65=1 1st digit from left ^{*3}	0 to 127	-	100 ('d')	Yes	Enabled
FA71	FA65=1 2nd digit from left ^{*3}	0 to 255	-	65 ('a')	Yes	Enabled
FA72	FA65=1 3rd digit from left ^{*3}	0 to 255	-	116 ('t')	Yes	Enabled
FA73	FA65=1 4th digit from left ^{*3}	0 to 127	-	65 ('a')	Yes	Enabled
FA74	FA65=1 unit ^{*3}	0 to 3	-	0	Yes	Enabled
FA75	FA65=2 1st digit from left ^{*3}	0 to 127	-	48 ('0')	Yes	Enabled
FA76	FA65=2 2nd digit from left ^{*3}	0 to 255	-	48 ('0')	Yes	Enabled
FA77	FA65=2 3rd digit from left ^{*3}	0 to 255	-	48 ('0')	Yes	Enabled
FA78	FA65=2 4th digit from left ^{*3}	0 to 127	-	48 ('0')	Yes	Enabled
FA79	FA65=2 unit ^{*3}	0 to 3	-	0	Yes	Enabled
FA80	LED display/Block communication switching ^{*3}	0 to 1	-	0	Yes	Enabled
FA87	Reset check data ^{*2}	0 to 255	-	0	Yes	Disabled

- *1 Before setting this parameter, enable the communication command or the frequency command from communication. How to enable-> Refer to [9. 1 Command through communication].
- *2 Refer to [9. 1 Command through communication].
- *3 Detail -> Refer to [9. 3 Using the panel (LED, keys) through communication]

- Monitor parameter * The parameters listed in the table below are used for read (monitor) only.

Communication No.		Function	Unit	Remarks
Current value	*4. Trip record retention			
0999	-	Acc/Dec time unit record	-	Refer to [Chapter 10]
FB05	-	Inverter capacity type	-	Refer to [A3]
FC00	-	Panel key monitor (effective value)	-	Refer to [9. 3]
FC90	-	Current trip	-	Refer to [9. 2]
FC91	-	Alarm	-	
FD00	FE00	Output frequency	0.01Hz	
FD01	FE01	Inverter status	-	
FD02	FE02	Frequency command value	0.01Hz	
FD03	FE03	Output current	0.01%	
FD04	FE04	Input voltage (DC detection)	0.01%	
FD05	FE05	Output voltage	0.01%	
FD06	FE06	Input terminal status	-	Refer to [9. 2]
FD07	FE07	Output terminal status	-	
FE08	-	Inverter CPU version	-	
FE10	-	Past trip 1 (latest)	-	Refer to [9. 2]
FE11	-	Past trip 2	-	
FE12	-	Past trip 3	-	
FE13	-	Past trip 4	-	
FD10	-	Past trip 5	-	
FD11	-	Past trip 6	-	
FD12	-	Past trip 7	-	
FD13	-	Past trip 8 (oldest)	-	
FE14	-	Cumulative run time	1 = 1 hour	
FD15	FE15	Motor primary frequency	0.01Hz	
FD16	FE16	Speed feedback frequency	0.01Hz	
FD18	FE18	Torque	0.01%	
FD19	FE19	Torque command	0.01%	
FD20	FE20	Torque current	0.01%	

Communication No.		Function	Unit	Remarks
Current value	*4. Trip record retention			
FD21	FE21	Exciting current	0.01%	
FD22	FE22	PID feedback value	0.01Hz	
FD23	FE23	Motor overload factor (OL2 data)	0.01%	
FD24	FE24	Inverter overload factor (OL1 data)	0.01%	
FD25	FE25	Braking resistor overload factor (OLr data)	1%	
FD26	FE26	Motor load factor	1%	
FD27	FE27	Inverter load factor	1%	
FD28	FE28	Braking resistor load factor (%ED)	1%	
FD29	FE29	Input power	0.01KW	
FD30	FE30	Output power	0.01KW	
FD32	-	Number of starting	1 = 1000 times	
FD33	-	Number of Fwd starting		
FD34	-	Number of Rev starting		
FE35	-	Terminal RR input value (Data range: 0 to 100.00%)	0.01%	Refer to [9. 2]
FE36	-	Terminal RX input value (Data range: -100.00 to 100.00%)		
FE37	-	Terminal II input value (Data range: 0 to 100.00%)		
FE38	-	Terminal AI4 input value (Data range: -100.00 to 100.00%)		
FE39	-	Terminal AI5 input value (Data range: 0 to 100.00%)		
FE40	-	Terminal FM output value	0.01%	
FE41	-	Terminal AM output value		
FD41	-	Cumulative cooling fan run time	1 = 10 hours	
FD42	FE42	Inverter status 2	-	Refer to [9. 2]
FD43	-	Terminal FP pulse train output value	pps	
FD45	-	Run command status	-	Refer to [9. 2]
FD46	-	Frequency command status	-	
FD48	FE48	PID result frequency	0.01%	

Communication No.		Function	Unit	Remarks
Current value	*4. Trip record retention			
FD49	FE49	Inverter status 3	-	Refer to [9. 2]
FD50	-	Light-load high-speed switching load torque	0.01%	
FD51	-	Light-load high-speed torque during constant speed run	0.01%	
FE56	-	Terminal S4/S5 pulse train input value	pps	
FE60	-	My function monitor output 1	-	
FE61	-	My function monitor output 2	-	
FE62	-	My function monitor output 3	-	
FE63	-	My function monitor output 4	-	
FE70	-	Inverter rated current	0.1A	
FE71	-	Inverter rated voltage	0.1V	
FE76	-	Input cumulative power	Depending on the setting of [F749] ^{*5}	
FE77	-	Output cumulative power	1.0 = 1 kWh 1.0 = 10 kWh 1.0 = 100 kWh 1.0 = 1000 kWh 1.0 = 10000 kWh 1.0 = 100000 kWh *6	F749 = 0 F749 = 1 F749 = 2 F749 = 3 F749 = 4 F749 = 5
FE79	-	Parts replacement alarm status	-	Refer to [9. 2]
FE80	-	Cumulative power ON time	1 = 10 hours	
FD90	FE90	Motor speed (estimated value)	min ⁻¹	Refer to [9. 2]

* 4 If a trip occurred, you see data with the status before the trip retained.

* 5 The values based on the monitor display are described in the inverter instruction manual (E6582062). These values are different from data read from communication.

* 6 Convert a value read from communication to calculate integral output power.

Example: When a read value of [FE76] is 2.5 with [F749] = [2: 1.0 = 100 kWh], integral output power is calculated as follows: 2.5 x 100 kWh = 250 kWh.

A1 | <Appendix 1> Data code table

■ JIS (ASCII) code

High Low	0	1	2	3	4	5	6	7
0	NUL	TC7 (DLE)	(SP)	0	@	P	,	p
1	TC ₁ (SOH)	DC ₁	!	1	A	Q	a	q
2	TC ₂ (STX)	DC ₂	"	2	B	R	b	r
3	TC ₃ (ETX)	DC ₃	#	3	C	S	c	s
4	TC ₄ (EOT)	DC ₄	\$	4	D	T	d	t
5	TC ₅ (ENQ)	TC ₈ (NAK)	%	5	E	U	e	u
6	TC ₆ (ACK)	TC ₉ (SYN)	&	6	F	V	f	v
7	BEL	TC ₁₀ (ETB)	'	7	G	W	g	w
8	FE ₀ (BS)	CAN	(8	H	X	h	x
9	FE ₁ (HT)	EM)	9	I	Y	i	y
A	FE ₂ (LF)	SUB	*	:	J	Z	j	z
B	FE ₃ (VT)	ESC	+	;	K	[k	{
C	FE ₄ (FF)	IS ₄ (FS)	,	<	L	\	l	
D	FE ₅ (CR)	IS ₃ (GS)	-	=	M]	m	}
E	SO	IS ₂ (RS)	.	>	N	^	n	—
F	SI	IS ₁ (US)	/	?	O	_	o	DEL

CR: Carriage return

Example: Code "41" = Character "A"

A2 | <Appendix 2> Response time

You can use data communication and inverter processing times to calculate a response time of communication.

When you need to calculate a response time of communication, refer to the following description:

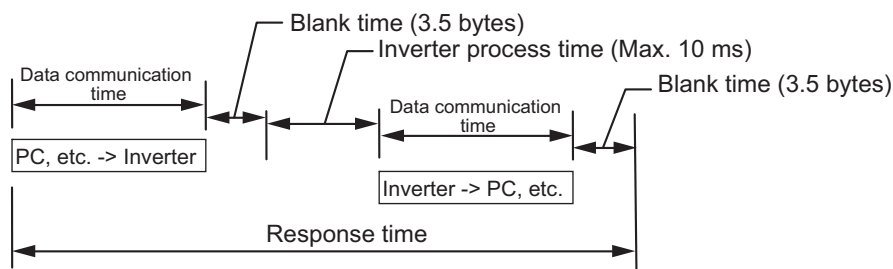

■ Data communication time

$$\text{Data communication time} = \frac{1}{\text{Communication speed}} \times \text{Number of communication bytes} \times \text{Number of bits}$$

- Number of bits = Start bit + Data length + Parity bit + Stop bit
- Minimum number of bits = 1 + 8 + 0 + 1 = 10 bits
- Maximum number of bits = 1 + 8 + 1 + 2 = 12 bits

Example of calculating a communication time: For 19200 bps, 8 bytes, 11 bits

$$\text{Data communication time} = \frac{1}{19200} \times 8 \times 11 = 4.6 \text{ ms}$$

■ Inverter processing time

Inverter processing time = Up to 10 ms

A3 | <Appendix 3> Inverter type (FB05)

I

■ Three-phase 200 V class

Type	Voltage/Capacity	Inverter type	
		Hexadecimal	Decimal
VFAS3-2004P	Three-phase 200/240 V 0.4 kW	2	2
VFAS3-2007P	Three-phase 200/240 V 0.75 kW	4	4
VFAS3-2015P	Three-phase 200/240 V 1.5 kW	6	6
VFAS3-2022P	Three-phase 200/240 V 2.2 kW	7	7
VFAS3-2037P	Three-phase 200/240 V 3.7 kW	9	9
VFAS3-2055P	Three-phase 200/240 V 5.5 kW	A	10
VFAS3-2075P	Three-phase 200/240 V 7.5 kW	B	11
VFAS3-2110P	Three-phase 200/240 V 11 kW	6C	108
VFAS3-2150P	Three-phase 200/240 V 15 kW	6D	109
VFAS3-2185P	Three-phase 200/240 V 18.5 kW	6E	110
VFAS3-2220P	Three-phase 200/240 V 22 kW	6F	111
VFAS3-2300P	Three-phase 200/240 V 30 kW	70	112
VFAS3-2370P	Three-phase 200/240 V 37 kW	71	113
VFAS3-2450P	Three-phase 200/240 V 45 kW	72	114
VFAS3-2550P	Three-phase 200/240 V 55 kW	73	115

1

2

3

4

5

6

7

8

9

10

A1

A2

A3

A4

■ Three-phase 400 V class

Type	Voltage/Capacity	Inverter type	
		Hexadecimal	Decimal
VFAS3-4004PC	Three-phase 380/480 V 0.4 kW	22	34
VFAS3-4007PC	Three-phase 380/480 V 0.75 kW	24	36
VFAS3-4015PC	Three-phase 380/480 V 1.5 kW	26	38
VFAS3-4022PC	Three-phase 380/480 V 2.2 kW	27	39
VFAS3-4037PC	Three-phase 380/480 V 3.7 kW	29	41
VFAS3-4055PC	Three-phase 380/480 V 5.5 kW	2A	42
VFAS3-4075PC	Three-phase 380/480 V 7.5 kW	2B	43
VFAS3-4110PC	Three-phase 380/480 V 11 kW	2C	44
VFAS3-4150PC	Three-phase 380/480 V 15 kW	2D	45
VFAS3-4185PC	Three-phase 380/480 V 18.5 kW	2E	46
VFAS3-4220PC	Three-phase 380/480 V 22 kW	2F	47
VFAS3-4300PC	Three-phase 380/480 V 30 kW	30	48
VFAS3-4370PC	Three-phase 380/480 V 37 kW	31	49
VFAS3-4450PC	Three-phase 380/480 V 45 kW	32	50
VFAS3-4550PC	Three-phase 380/480 V 55 kW	33	51
VFAS3-4750PC	Three-phase 380/480 V 75 kW	34	52
VFAS3-4900PC	Three-phase 380/480 V 90 kW	35	53
VFAS3-4110KPC	Three-phase 380/480 V 110 kW	36	54
VFAS3-4132KPC	Three-phase 380/480 V 132 kW	37	55
VFAS3-4160KPC	Three-phase 380/480 V 160 kW	38	56
VFAS3-4200KPC	Three-phase 380/480 V 200 kW	39	57
VFAS3-4220KPC	Three-phase 380/480 V 220 kW	3A	58
VFAS3-4280KPC	Three-phase 380/480 V 280 kW	3C	60

A3

■ Three-phase 400 V class (IP55)

Type	Voltage/Capacity	Inverter type	
		Hexadecimal	Decimal
VFAS3-4004PCE	Three-phase 380/480 V 0.4 kW	86	134
VFAS3-4007PCE	Three-phase 380/480 V 0.75 kW	88	136
VFAS3-4015PCE	Three-phase 380/480 V 1.5 kW	8A	138
VFAS3-4022PCE	Three-phase 380/480 V 2.2 kW	8B	139
VFAS3-4037PCE	Three-phase 380/480 V 3.7 kW	8D	141
VFAS3-4055PCE	Three-phase 380/480 V 5.5 kW	8E	142
VFAS3-4075PCE	Three-phase 380/480 V 7.5 kW	8F	143
VFAS3-4110PCE	Three-phase 380/480 V 11 kW	90	144
VFAS3-4150PCE	Three-phase 380/480 V 15 kW	91	145
VFAS3-4185PCE	Three-phase 380/480 V 18.5 kW	92	146
VFAS3-4220PCE	Three-phase 380/480 V 22 kW	93	147
VFAS3-4300PCE	Three-phase 380/480 V 30 kW	94	148
VFAS3-4370PCE	Three-phase 380/480 V 37 kW	95	149
VFAS3-4450PCE	Three-phase 380/480 V 45 kW	96	150
VFAS3-4550PCE	Three-phase 380/480 V 55 kW	97	151
VFAS3-4750PCE	Three-phase 380/480 V 75 kW	98	152

A4 | <Appendix 4> Troubleshooting

If a trip occurs, make failure diagnosis according to the table below before contacting your Toshiba distributor. If you cannot solve a problem even after taking actions described in the table below, or if you encounter a phenomenon not listed in the table below, contact the sales contact from which you purchased the inverter or Toshiba distributor.

Problems	Check items and actions	Reference
Communication cannot be established.	<ul style="list-style-type: none"> • Have you turned on the computer or inverter? • Are the cables wired properly? (You can check the sending and receiving status in "Communication status" of [Monitor mode] of the inverter. For details, refer to the inverter instruction manual (E6582062).) • Are the same communication protocol, baud rate, and parity used on a communications line? • Are the settings of [F809: Operation panel connection priority] and [F829: RS485 (2) wiring type] correct? • Is the pull-up/pull-down resistor used? • Is a blank time of 3.5 bytes or more set before and after the reception frames? 	<p>Inverter instruction manual</p> <p>[8. 1]</p> <p>[Chapter 8]</p> <p>[Chapter 3]</p> <p>[4. 1]</p>
An error is returned.	<ul style="list-style-type: none"> • Is the transmission format correct? • Isn't the written data out of range? • While the inverter is running, no data can be written to some parameters. For parameters for which writing is prohibited while the inverter is running, write data to them when the inverter stops. • Isn't [F700: Parameter reading&writing access lockout] set to "2: Writing locked (1+RS485)" or "4: Reading&Writing locked (3+RS485)"? • No data can be written to [F738] when [F738: Password setting] is set. 	<p>[5. 1]</p> <p>[6. 1]</p> <p>[Chapter 10]</p> <p>Inverter instruction manual</p>
An [Err5] trip occurs.	<ul style="list-style-type: none"> • Check the wiring and timer setting time. 	[8. 3]
A frequency command from communication is not enabled.	<ul style="list-style-type: none"> • Is the frequency command selection set to communication? • Is "Communication priority cancel" ON? 	[9. 1]
A run or stop command from communication is not enabled.	<ul style="list-style-type: none"> • Is the run command selection set to communication? • Is "Communication priority cancel" ON? 	Inverter instruction manual
The changed value of a parameter does not take effect.	<ul style="list-style-type: none"> • The values of some communication-related parameters take effect after reset. Turn off and then on the inverter. 	[Chapter 8]

Problems	Check items and actions	Reference
<p>Although the value of a parameter was changed, the parameter is restored to its original value after the inverter is turned off.</p>	<ul style="list-style-type: none"> When using the Toshiba inverter protocol, use the "W" command for writing to EEPROM during a write operation. If you use the "P" command for writing to only RAM, the parameter is restored to its original value after the power of the inverter is reset. 	<p>[5. 2]</p>
	<ul style="list-style-type: none"> When [F897: Parameter writing] is set to "1", all writing via communication is only done to the RAM. From the operation panel, set [F897] to "0" and turn off the inverter to reset. 	<p>[8. 6]</p>
<p>The changed value of a parameter does not work properly.</p>	<ul style="list-style-type: none"> The setting values of some parameters take effect after the power of the inverter is reset. Some functions cannot be used in the MODBUS-RTU protocol. 	<p>[Chapter 8]</p>

